



Molecular Biology : **An introduction**

Dr. Puneet Saxena M.D

Associate Professor



What will you learn?

- Structure of nucleic acids
- Metabolism of nucleotides
- Replication of DNA
- Transcription
- Translation
- Expression of genes
- Techniques in molecular biochemistry
- Biochemistry of cancer and AIDS

Discovery of nucleic acids



- Friedrich Miescher 1869.
- Isolated what he called **nuclein** from the nuclei of pus cells.
- Nuclein was shown to have acidic properties, hence it became called **nucleic acid** by Richard Altmann

Types of nucleic acids

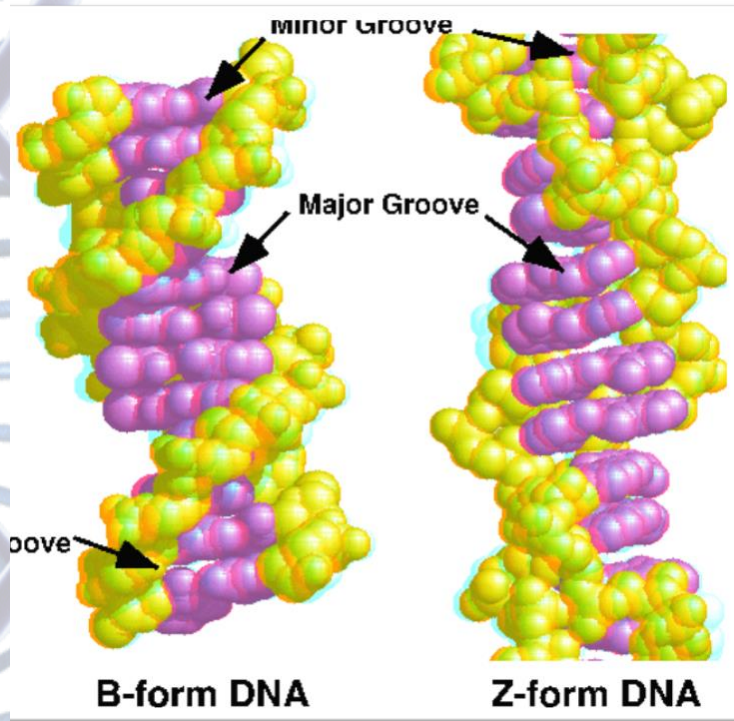



The distribution of nucleic acids in the eukaryotic cell

- DNA

- Nucleus
- Mitochondria
- Chloroplast

- RNA

- Throughout the cell



DNA as genetic material

- Present in all cells and virtually restricted to the nucleus
- The amount of DNA in somatic cells (body cells) of any given species is constant (like the number of chromosomes)
- The DNA content of gametes (sex cells) is half that of somatic cells.
- In cases of polyploidy (multiple sets of chromosomes) the DNA content increases by a proportional factor



NUCLEIC ACID STRUCTURE

- Nucleic acids are **polynucleotides**
- Their building blocks are **nucleotides**

Discovery of nucleic acids

- In 1919 *Phoebus Levene* identified the components (the four bases, the sugar and the phosphate chain)
- Components of DNA were linked in the order phosphate-sugar-base.
- He called each of these units a nucleotide and suggested the DNA molecule consisted of a string of nucleotide units linked together through the phosphate groups, which are the 'backbone' of the molecule

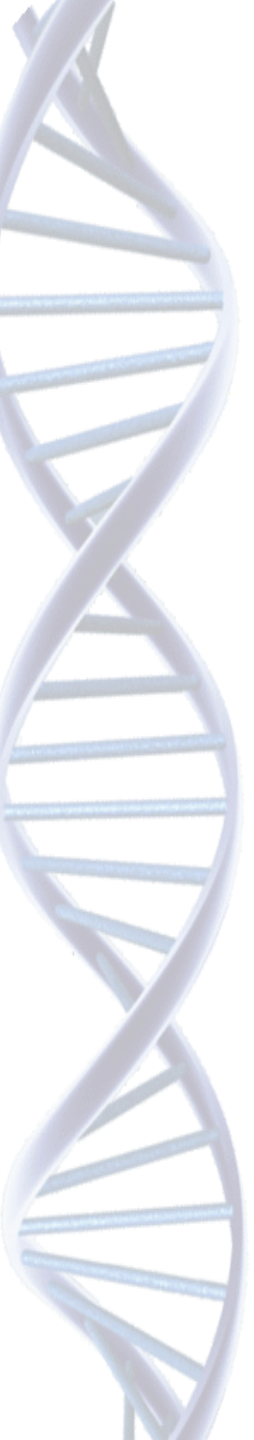

NUCLEOTIDE STRUCTURE

NUCLEOTIDE

PHOSPHATE

SUGAR

Ribose or
Deoxyribose

BASE

PURINES

Adenine (A)
Guanine (G)

PYRIMIDINES

Cytocine (C)
Thymine (T)
Uracil (U)

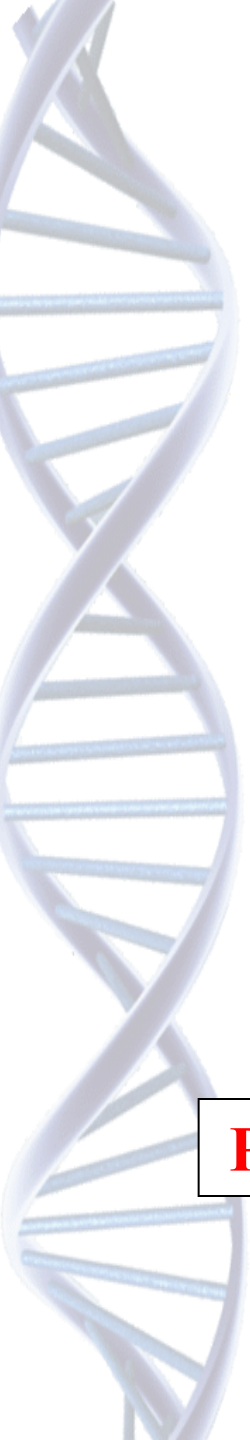

Ribose is a pentose

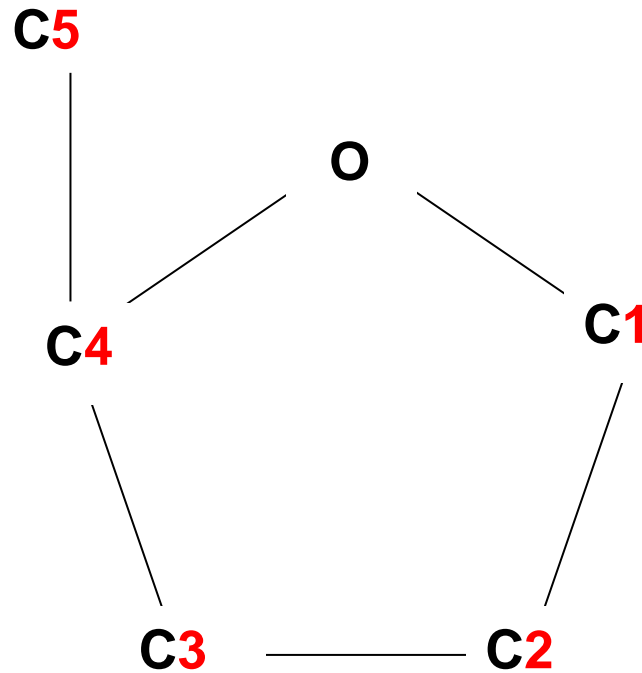

What's the difference

RIBOSE

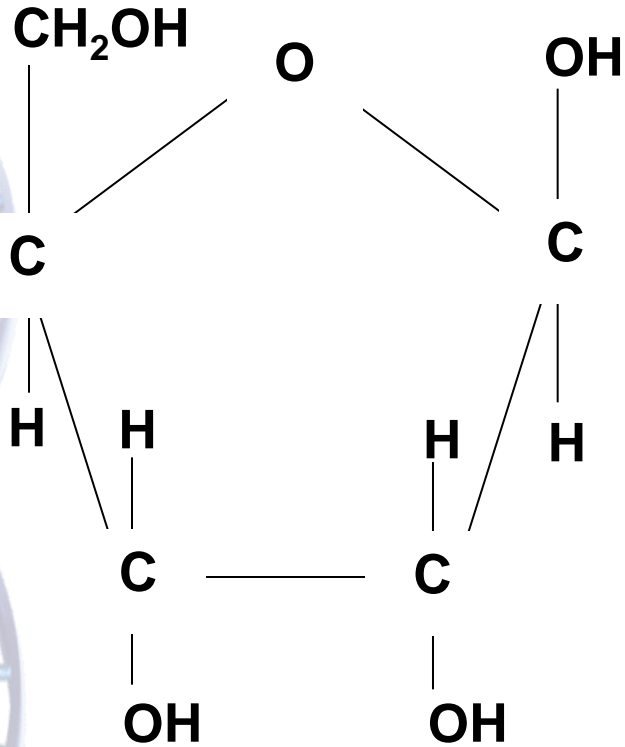

DEOXYRIBOSE

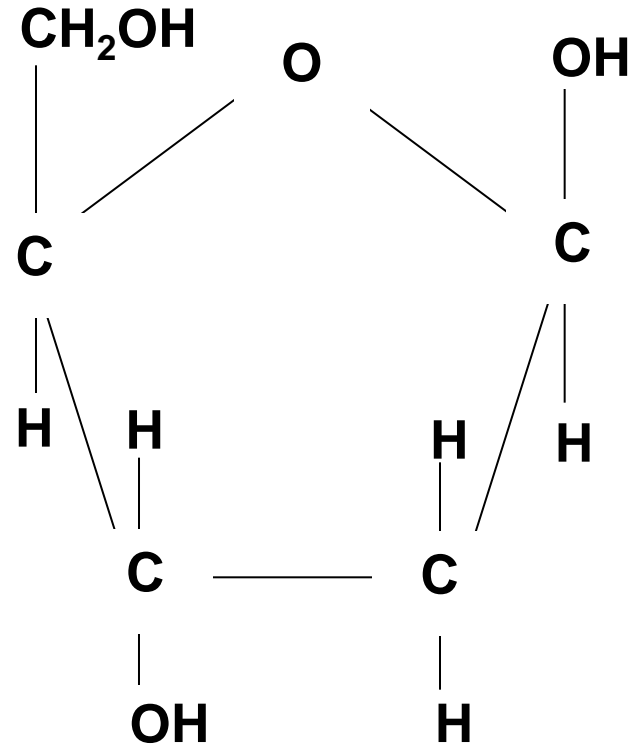

Nucleotides

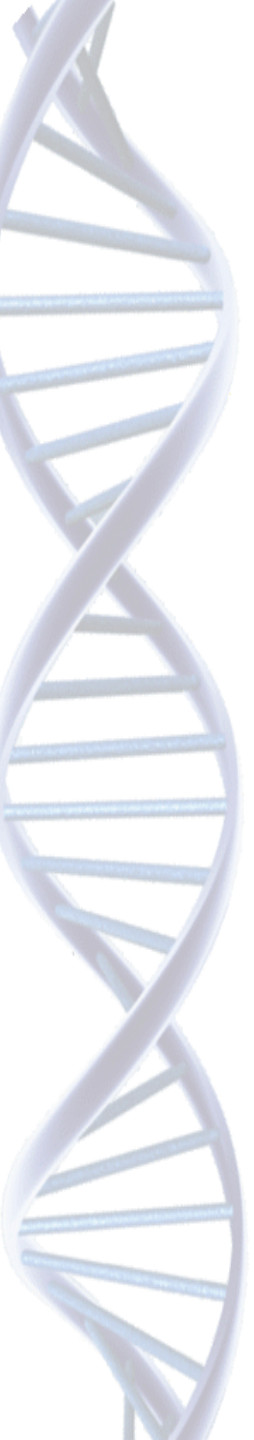
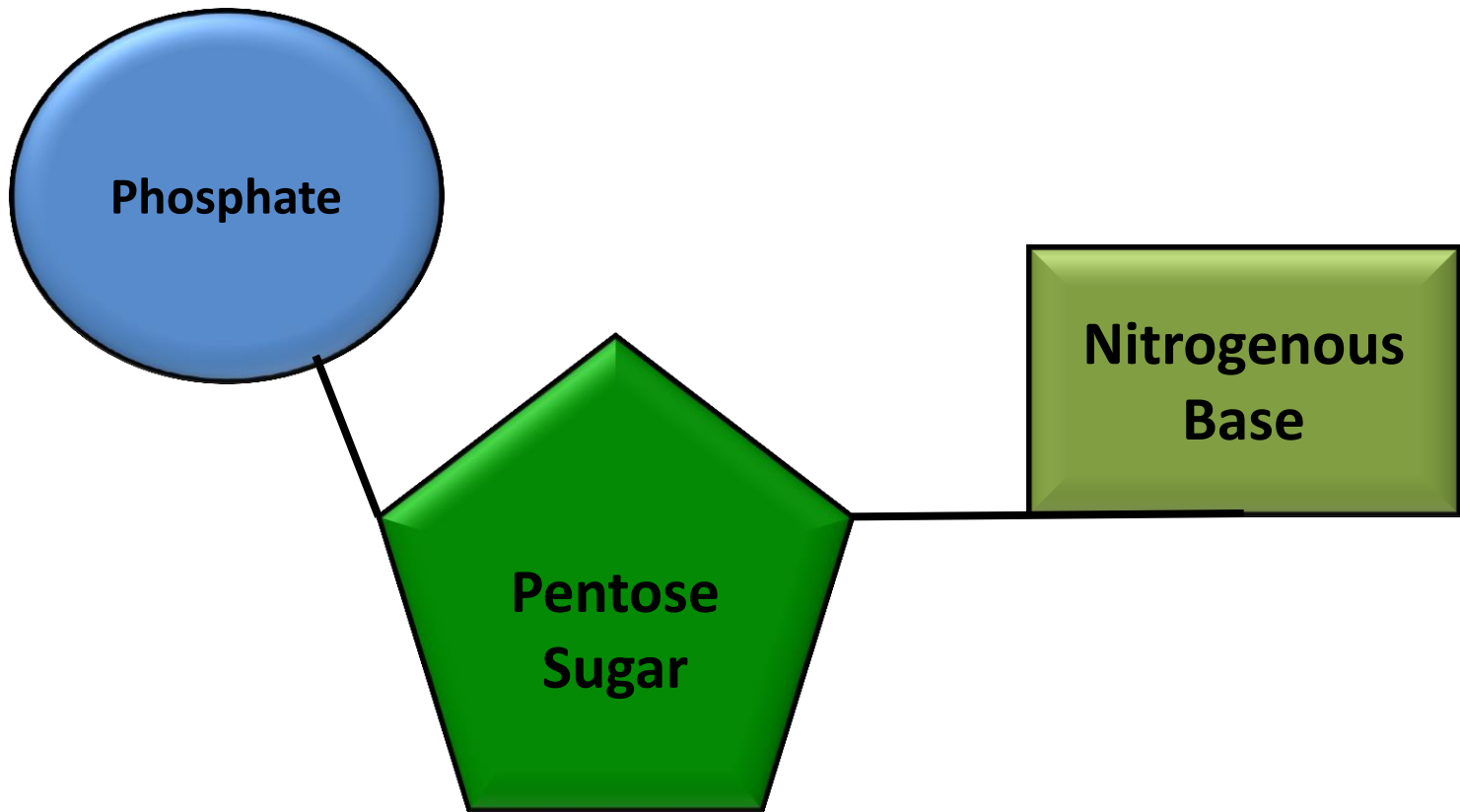

Nitrogenous Base

- Purines
 - Adenine
 - Guanine
 - Xanthine

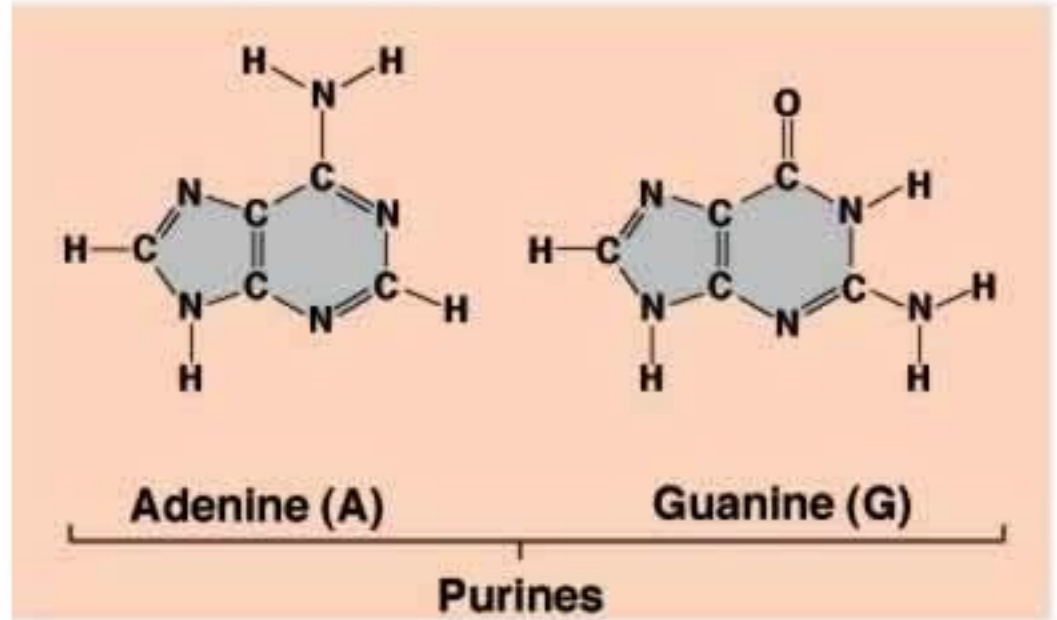

- Hypoxanthine

Nitrogenous Base

Pyrimidines

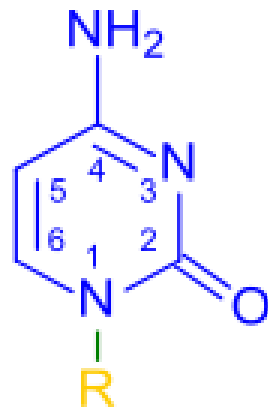

Cytosine

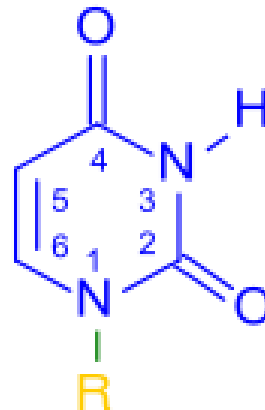

Uracil

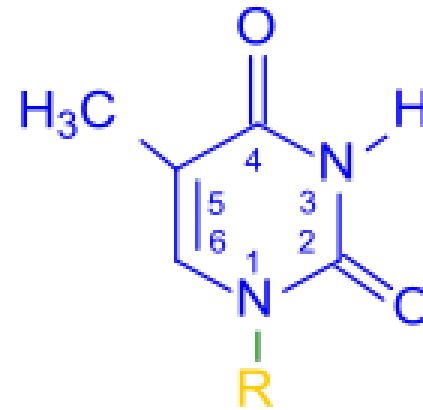

Thymine

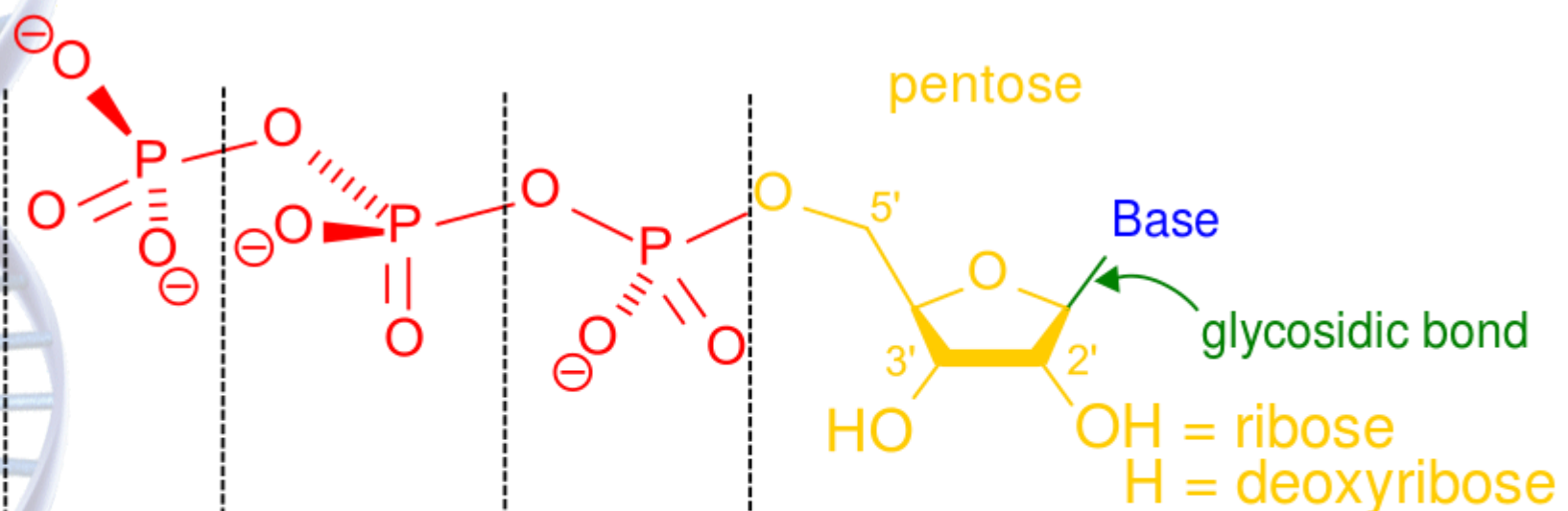
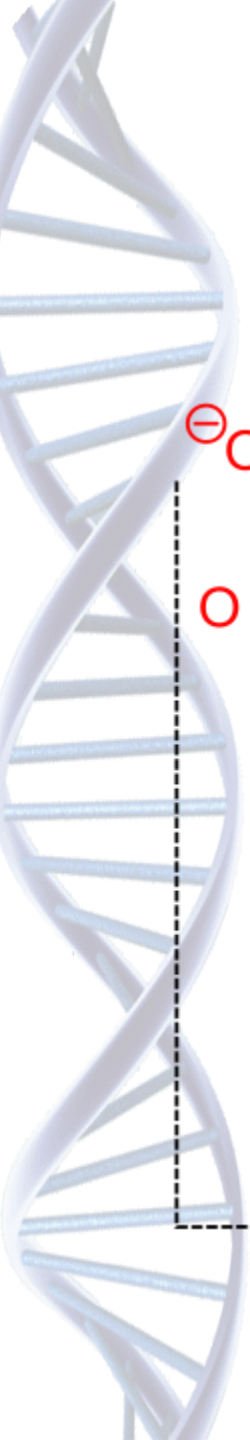

nucleoside

nucleoside monophosphate

nucleoside diphosphate

nucleoside triphosphate

Nucleoside

Nucleotide

Nitrogenous bases(Purines)

Base	Nucleoside	Nucleotide
Adenine	Adenosine	Adenylate
	Deoxyadenosine	Deoxyadenylate
Guanine	Guanosine	Guanylate
	Deoxyguanosine	Deoxyguanylate

Nitrogenous bases (Pyrimidines)

Base	Nucleoside	Nucleotide
Cytosine	Cytidine	Cytidylate
	Deoxycytidine	Deoxycytidylate
Thymine	Thymidine	Thymidylate
	Deoxythymidine	Deoxythymidilate
Uracil	Uridine	Uridylate
	?????????	?????????????



Structure of DNA

- Polymer of deoxyribonucleoside monophosphates covalently linked by 3' → 5'–phosphodiester bonds.
- Double stranded helical structure except in some viruses.
- Both strands are antiparallel.

THE SUGAR-PHOSPHATE BACKBONE

- The nucleotides are all orientated in the same direction
- The phosphate group joins the 3rd Carbon of one sugar to the 5th Carbon of the next in line.

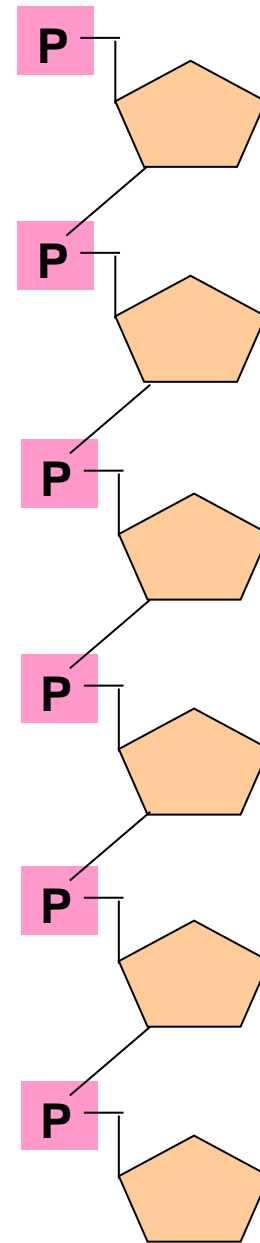

3' → 5' phosphodiester bond

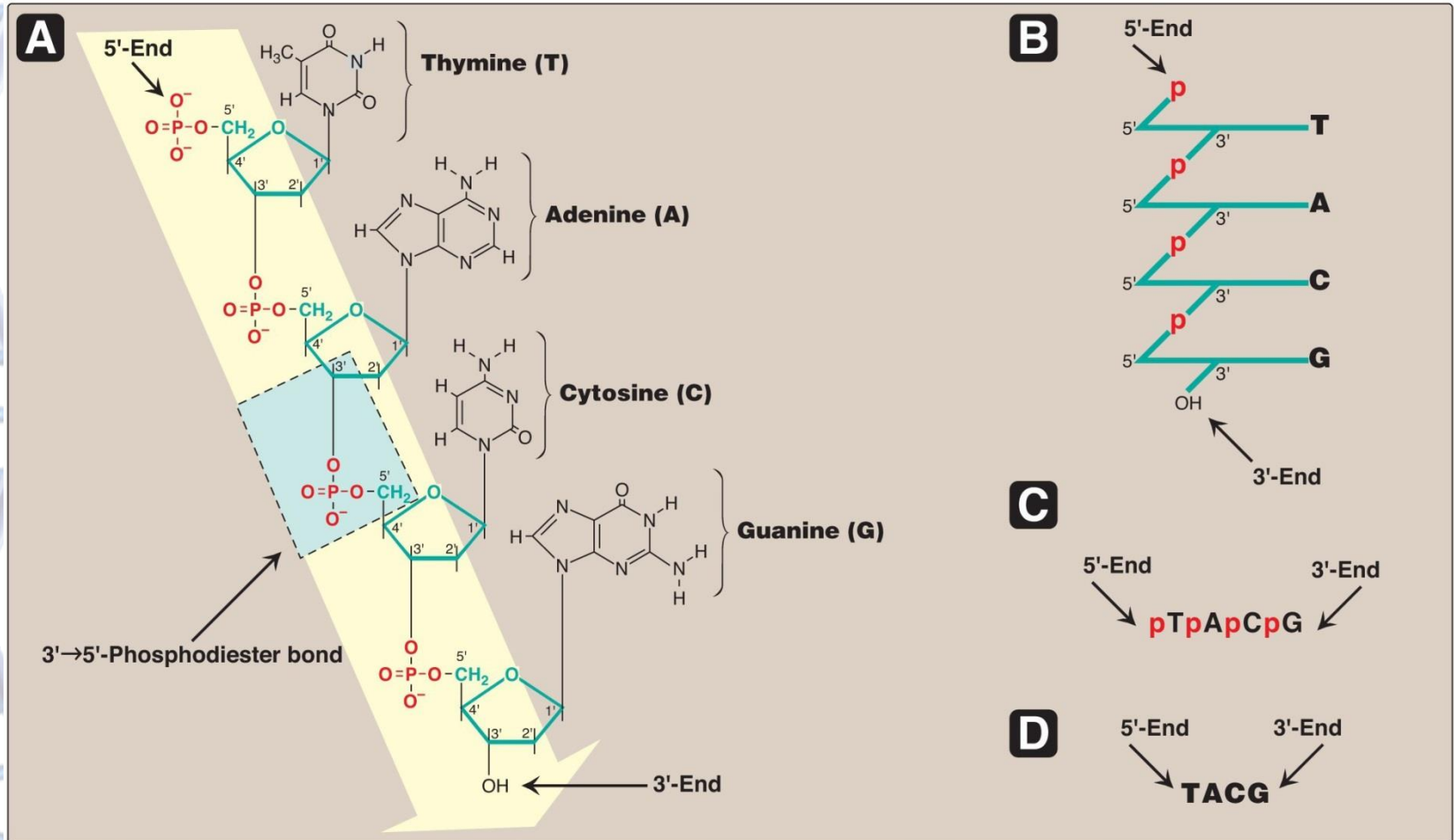

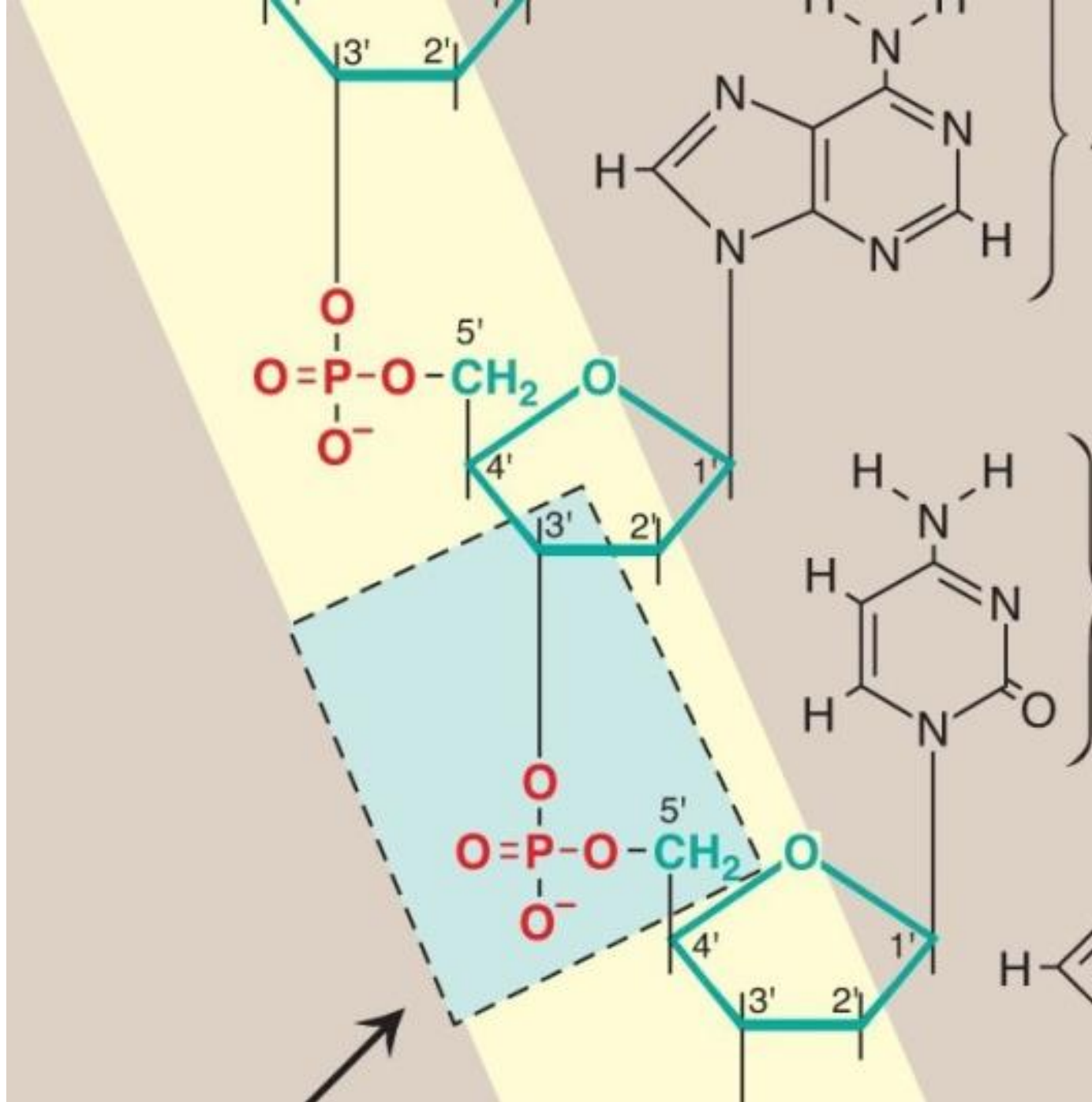
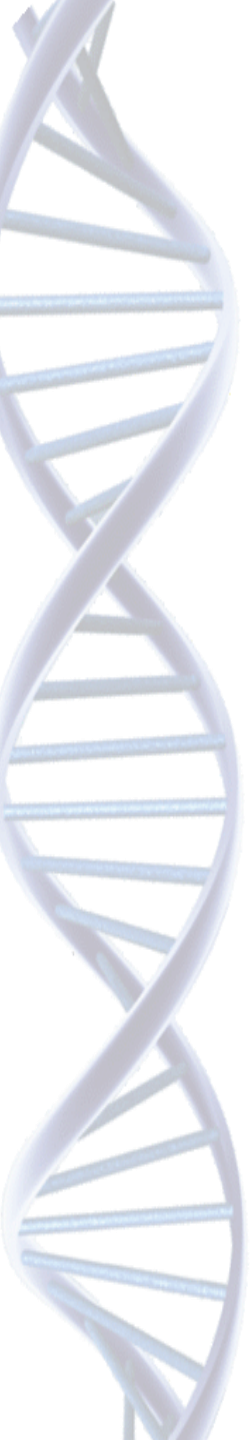

ADDING IN THE BASES

- The bases are attached to the 1st Carbon
- Their order is important
It determines the genetic information of the molecule

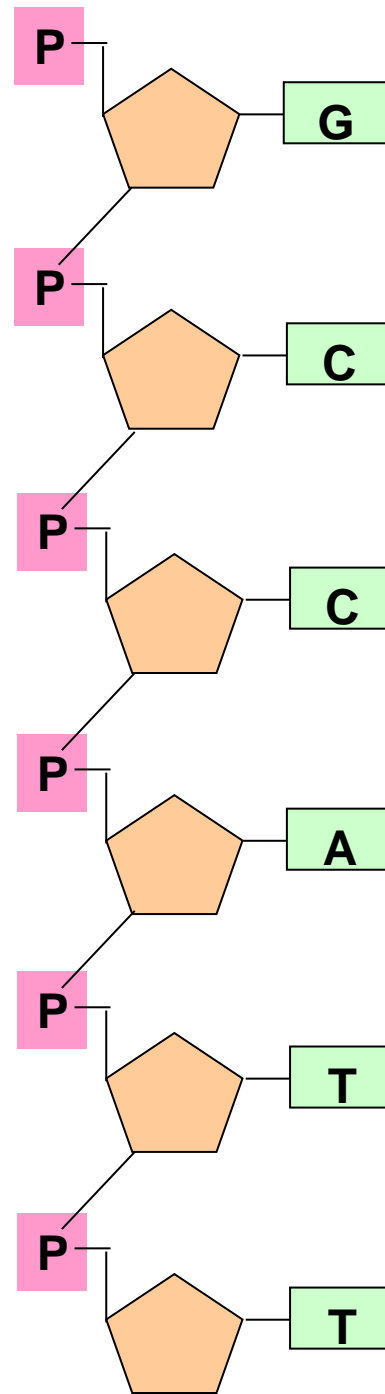

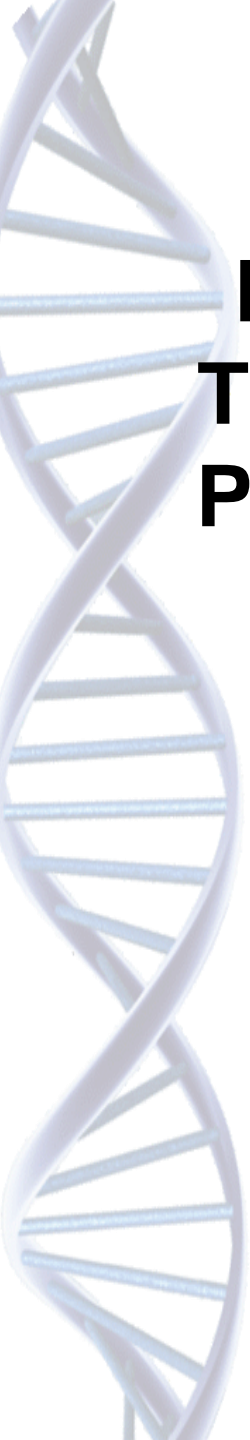

DNA IS MADE OF TWO STRANDS OF POLYNUCLEOTIDE

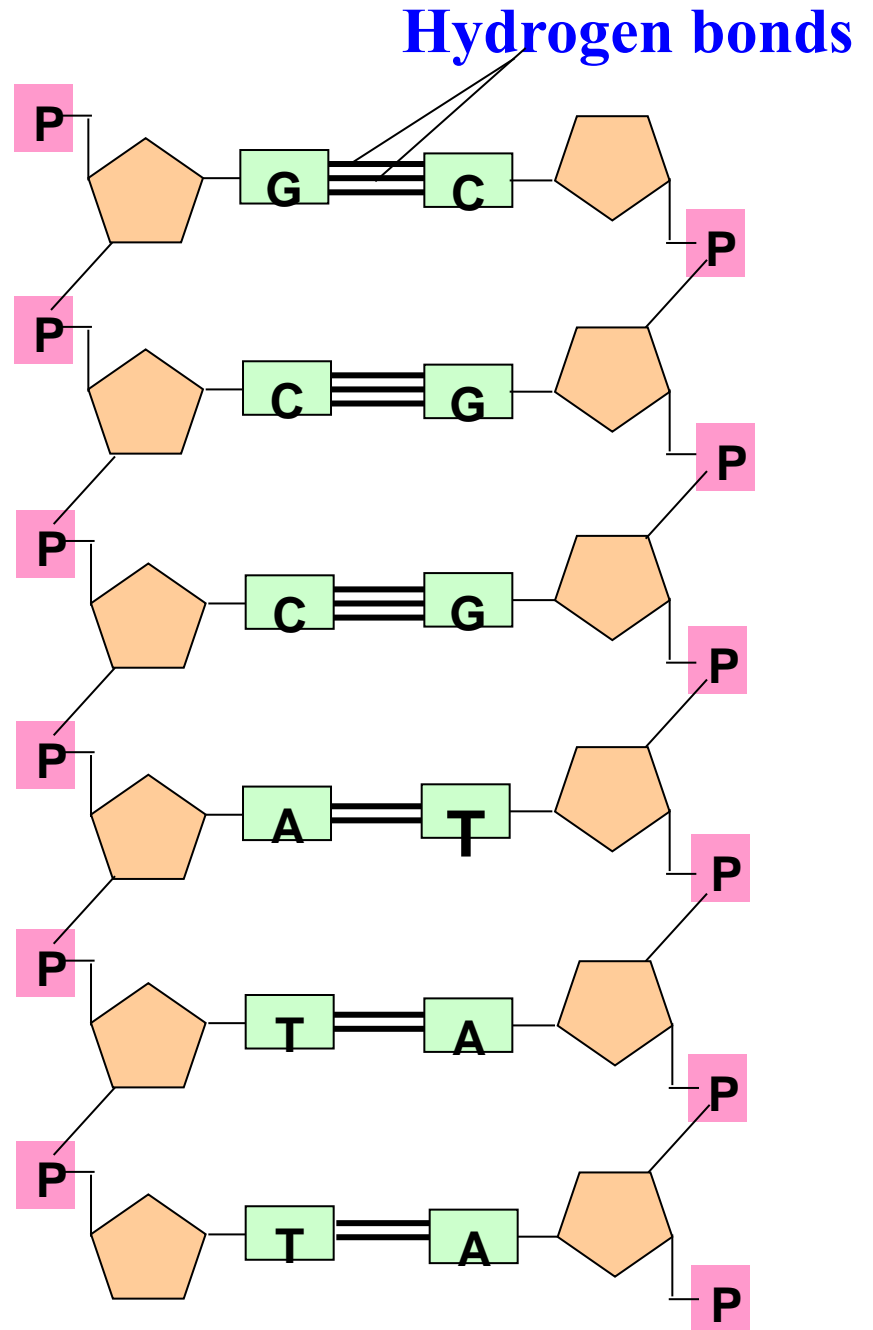



Functions of nucleotides

- *Nucleotides are the building blocks of nucleic acids (DNA and RNA).*
- *2. ATP is the universal energy currency of living systems.*
- *3. Cyclic nucleotides such as cAMP and cGMP act as 'second messengers'*
- *4. Nucleotides are the structural components of a number of coenzymes*



continues...

- They act as the ***carriers of*** certain ***metabolic intermediates*** of carbohydrates, (UDP-glucose), lipids (CDP-acyl glycerol) and proteins (S-adenosyl methionine-SAM).
- 6. UDP-Gal UDP-Glu, GDP-Man, CMP-NeuAc, GDPFuc, UDP-Xyl, UDP-Gal Nac and UDP-Glu Nac - These eight molecules are known as '***nucleotide-linked sugars***' and are important ***constituents of glycoproteins***

Structures of biologically important nucleotides

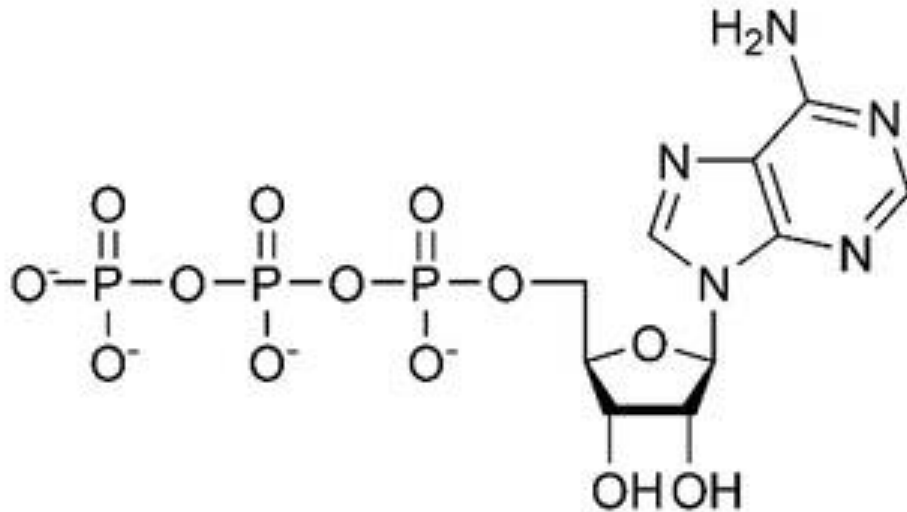

ATP

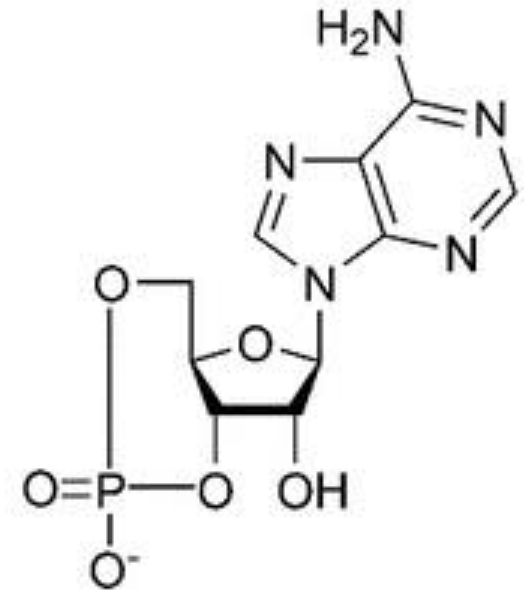

cAMP



Synthetic nucleotides

Therapeutic applications

- Synthetic nucleosides, cytarabine and vidarabine in which ribose is replaced by arabinose are used in *chemotherapy to treat cancers*.
- Allopurinol is used in the treatment of hyperuricemia and *gout*.



continues...

- Synthetic analogues such as 6-mercaptopurine, 5-fluorouracil, 5-iodouracil, 3-deoxyuridine, 5 or 6-azauridine, 5- or 6-azacytidine, 8-azaguanine, 6-thioguanine are widely used by oncologists. They are incorporated into DNA just before cell division, thus blocking cell proliferation.
- Drugs like zidovudine which are used in the treatment of AIDS are synthetic nucleotide analogues with alterations in the sugar structure.

Structure of DNA

- The double helical structure of DNA was first proposed by James Watson and Francis Crick in 1953

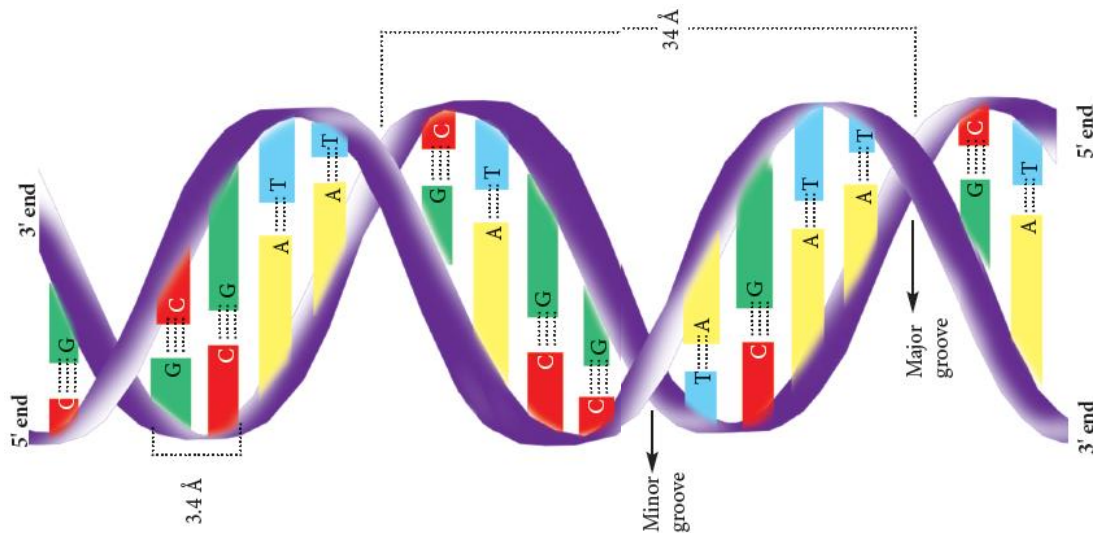

Wilkins & Franklin (1952): X-ray crystallography

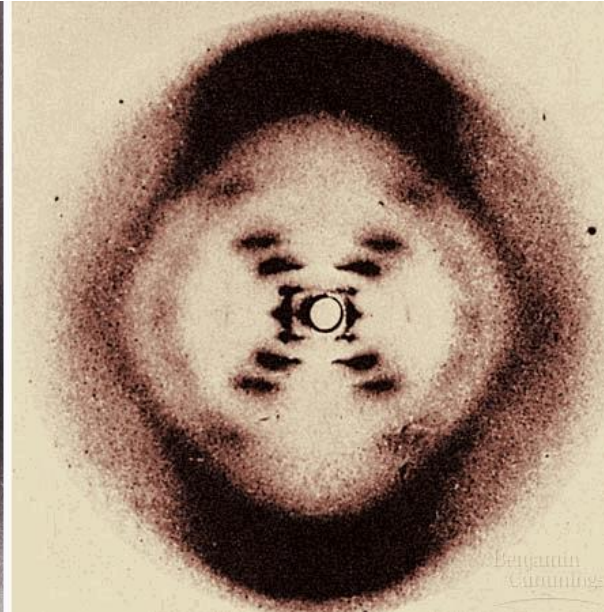

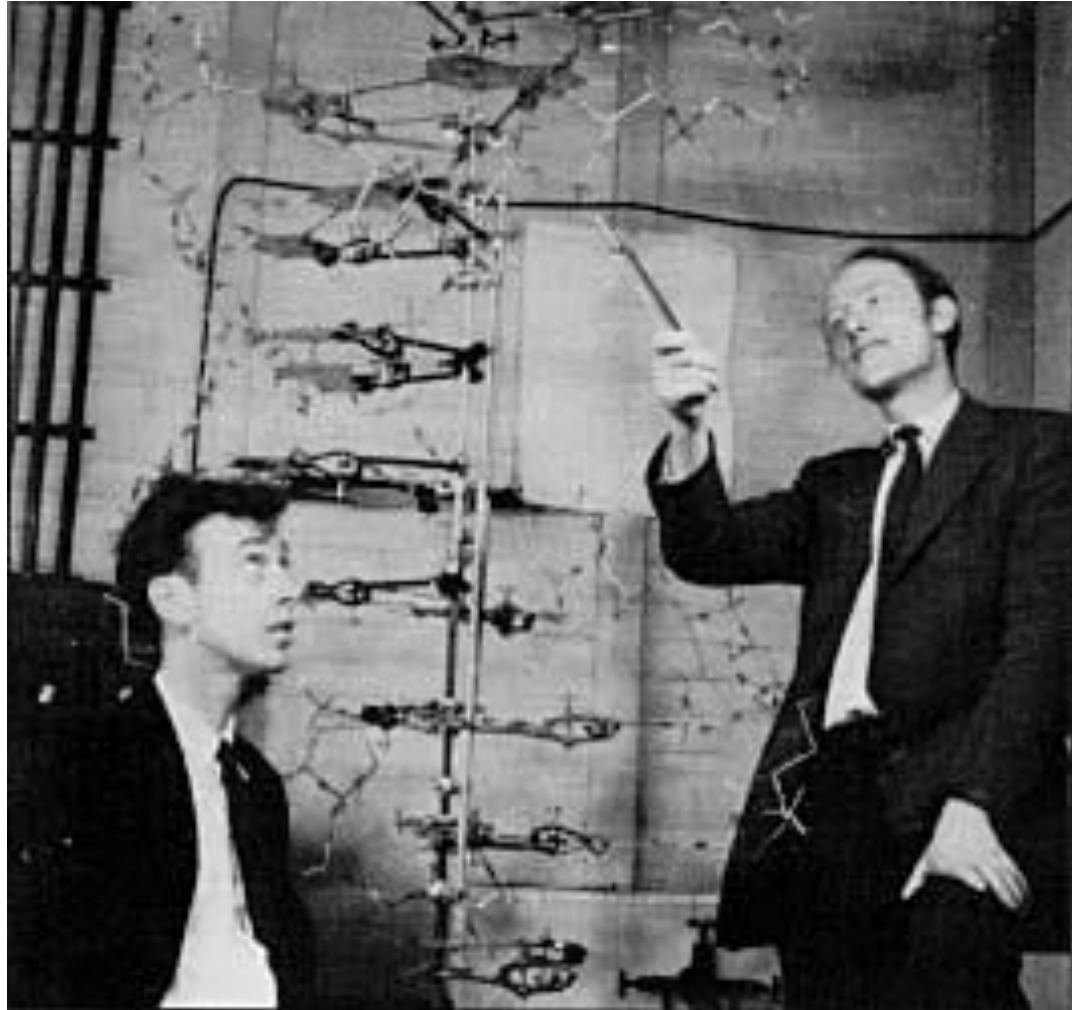
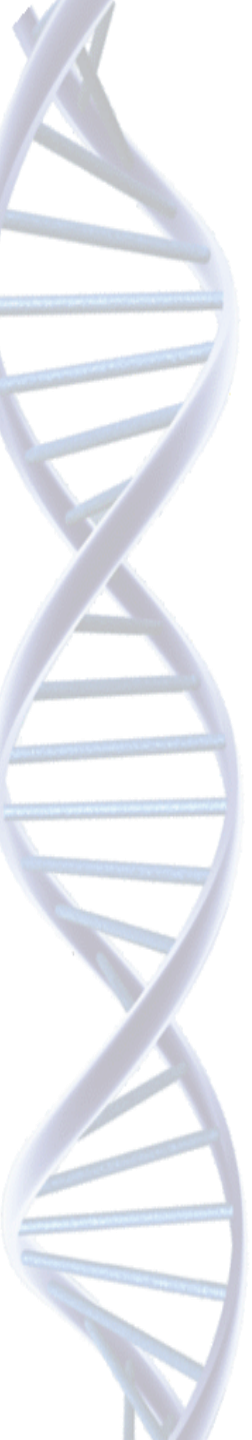



Double helical structure

- Right handed Double helix
- Antiparallel
- The two chains are coiled around a common axis called the axis of symmetry.
- The hydrophilic deoxyribose–phosphate backbone outside of
- Hydrophobic bases are stacked inside

Hydrogen bonds between bases

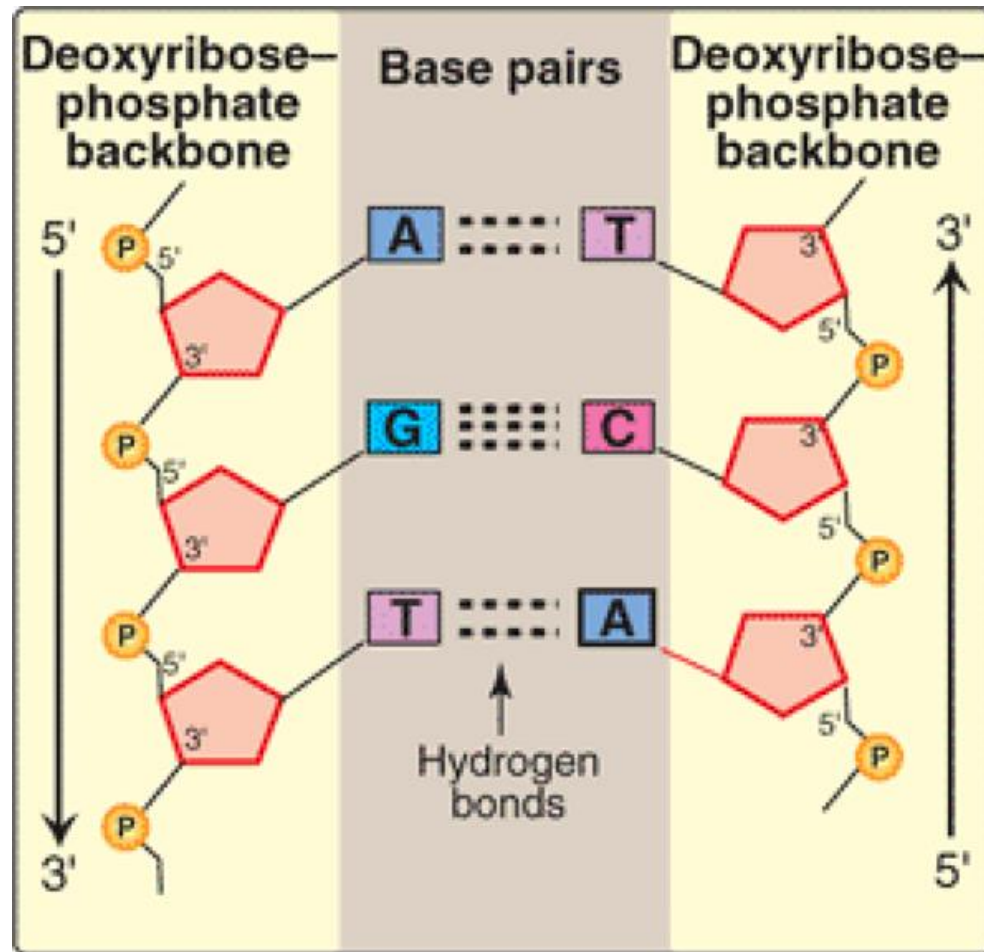

Why there is always pairing between a purine and pyrimidine?

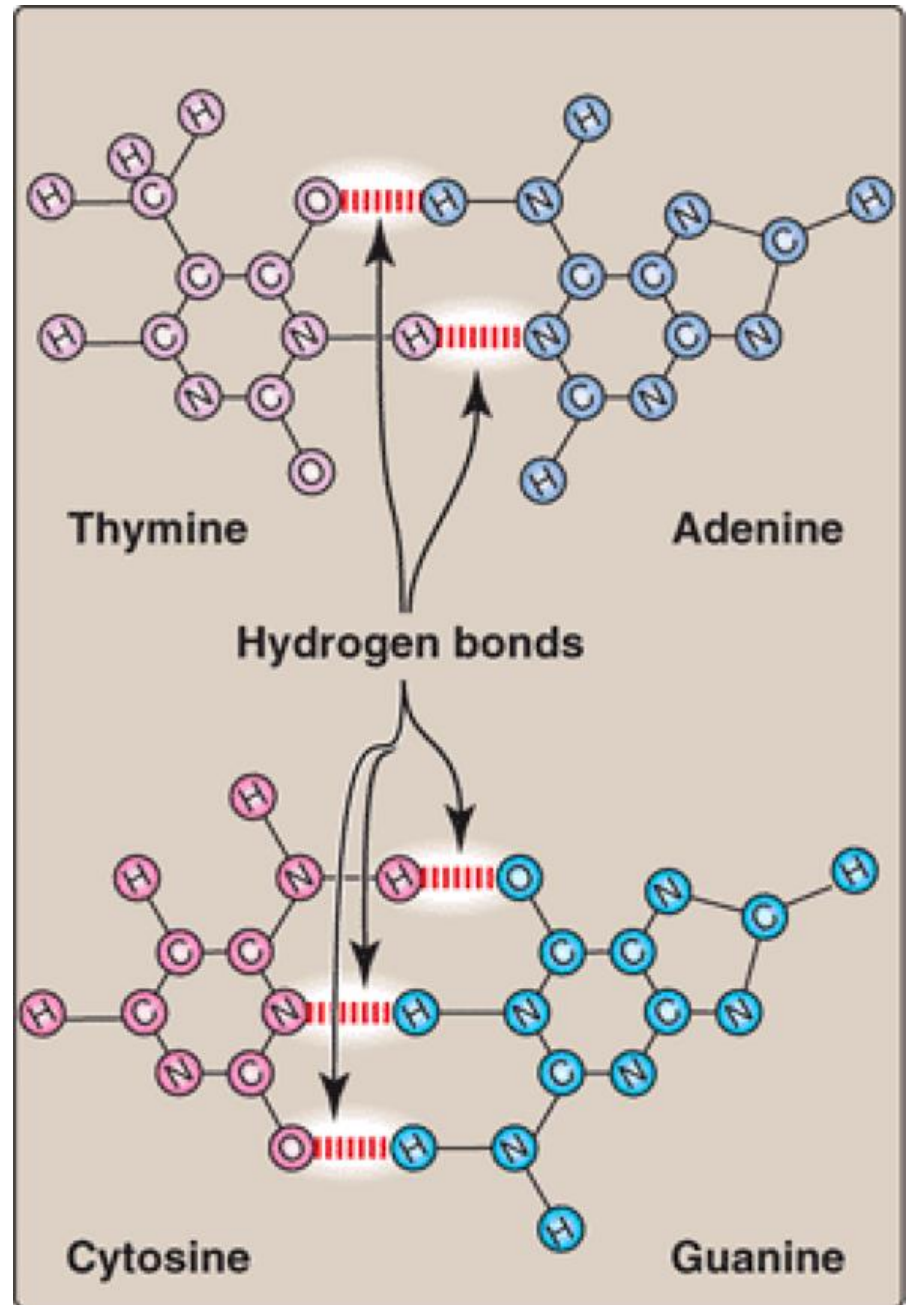



continues...

- The ring structure of each base occurs in a flat plane perpendicular to the sugar–phosphate backbone, resembling the steps on a spiral staircase.
- The base pairing maintains a constant distance between the sugar–phosphate backbones of the two strands as they twist around each other.



continues...

- This is known as ***complementary base pairing***. *This specificity has tremendous significance in DNA self replication and transcription.*
- It is more difficult to separate the paired DNA strands rich in G–C pairing because G≡C (three double bonds) pairing is stronger than A=T (two double bonds) pairing.



continues...

- The coiling of two strands creates a ***major groove*** and a ***minor groove*** on the surface of the duplex. Proteins interact with DNA at these grooves without disrupting the double helix.
- Access for binding of regulatory proteins
- Actinomycin D binds with narrow groove

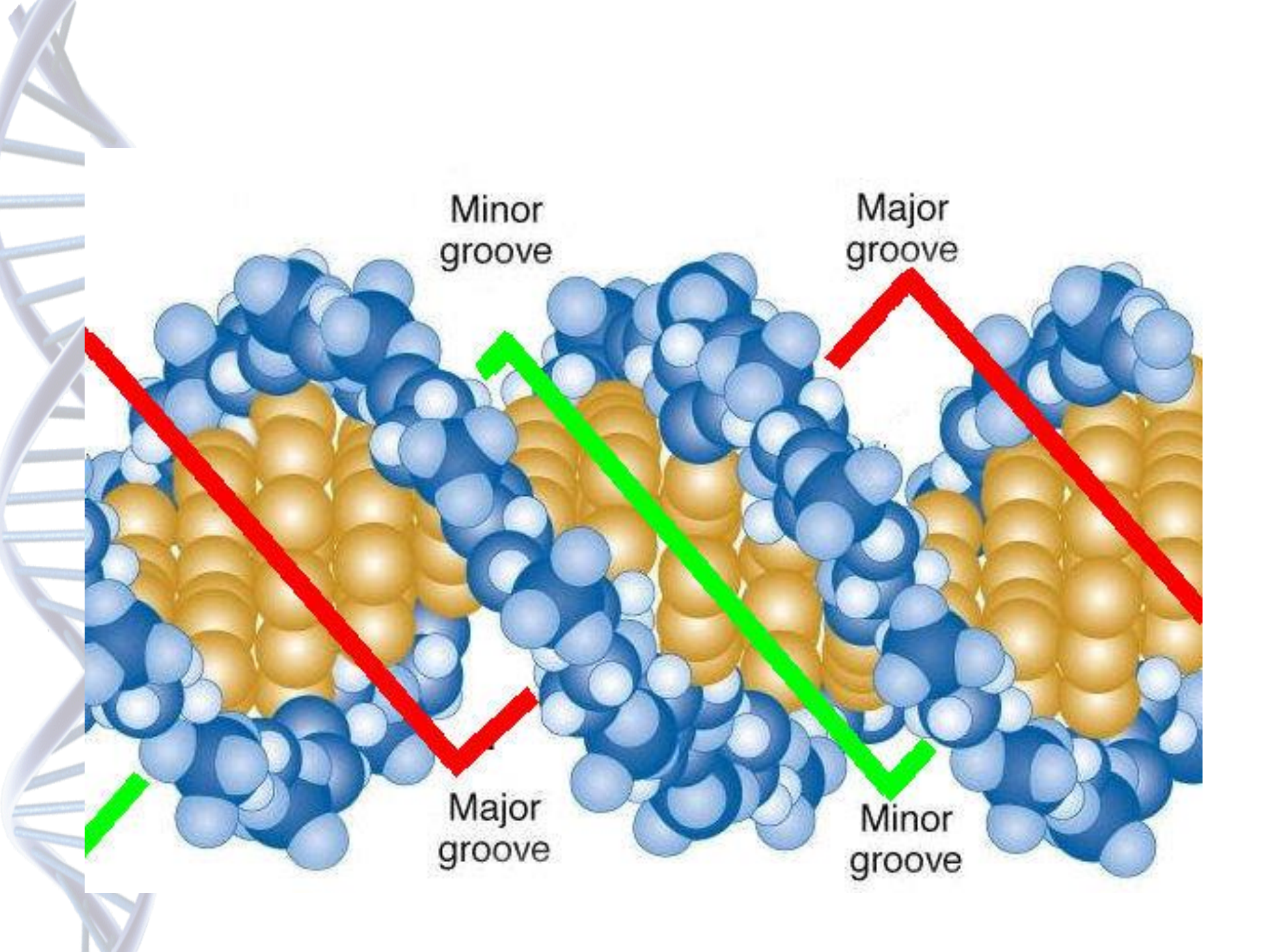

- 
- ***Geometry of the DNA duplex:*** The width of a double helix is 20 Å. Each turn of the helix is 34 Å with 10 pairs of nucleotides, each pair is placed at a distance of 3.4 Å.
 - Because of their length, DNA chains are described in terms of base pairs (bp) or thousands of base pairs (kilobase pairs or kb), e.g. [5 kb (virus), 2,50,000 kb (humans)].

Types of DNA

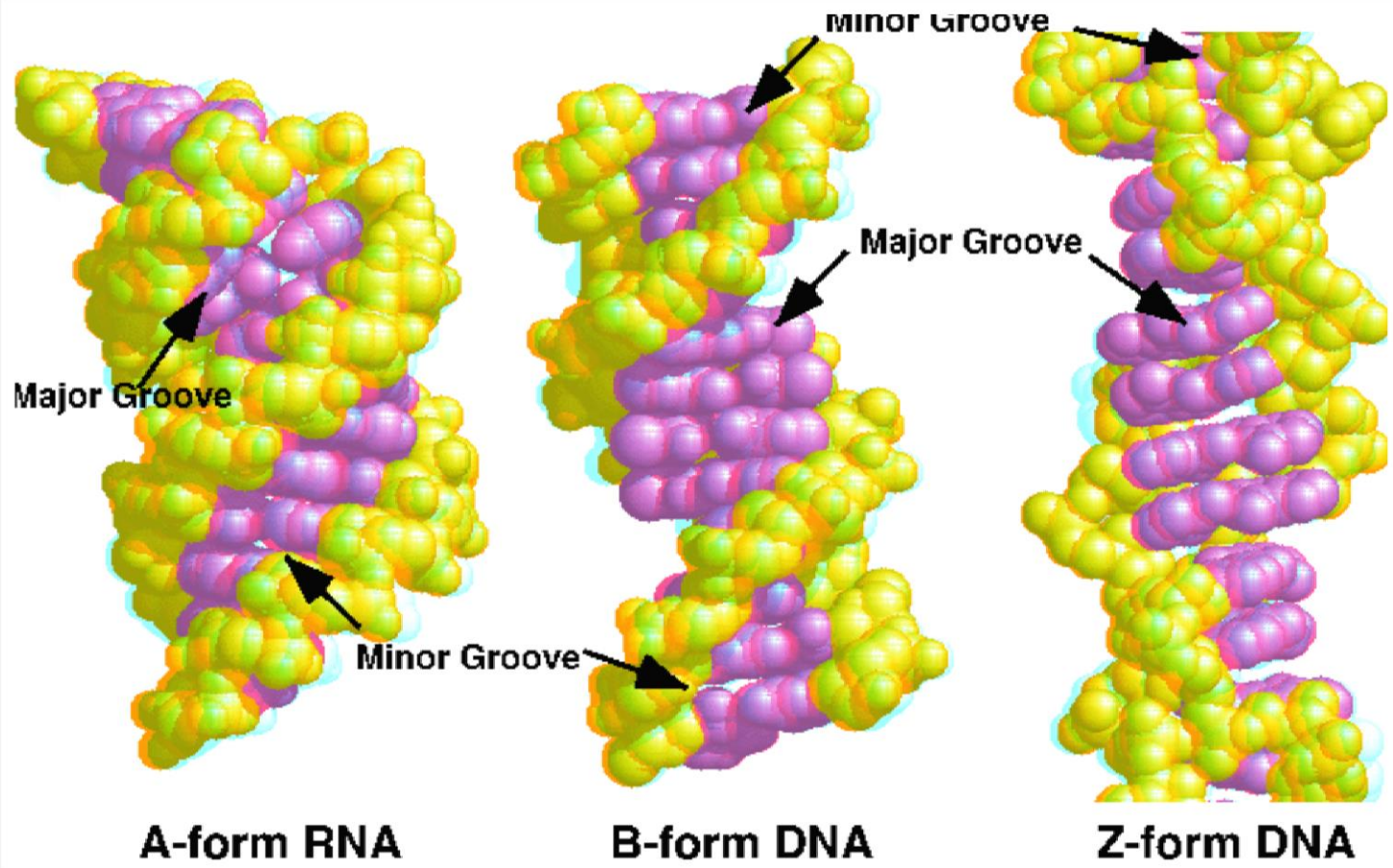



	A-DNA	B-DNA	Z-DNA
Helix	Right	Right	Left
Diameter	26 A°	34 A°	18 A°
Base pair per turn	11	10.4	12
Pitch	2.46 nm	3.4 nm	1.84 nm
Major groove	Present	Present	Convax
Minor groove	Present	Present	Deep

