

Life cycle of Fatty acid in Humans

SMPatel

FA - Food Sources (TG)



GLASBERGEN

“Today I ate two bowls of dog food, a sandwich crust, some spaghetti that fell on the floor, half of your cat food, a wet tea bag, three bugs and the inside of a sneaker. How many grams of fat is that?”

Digestion – Lipase, Bile Salt

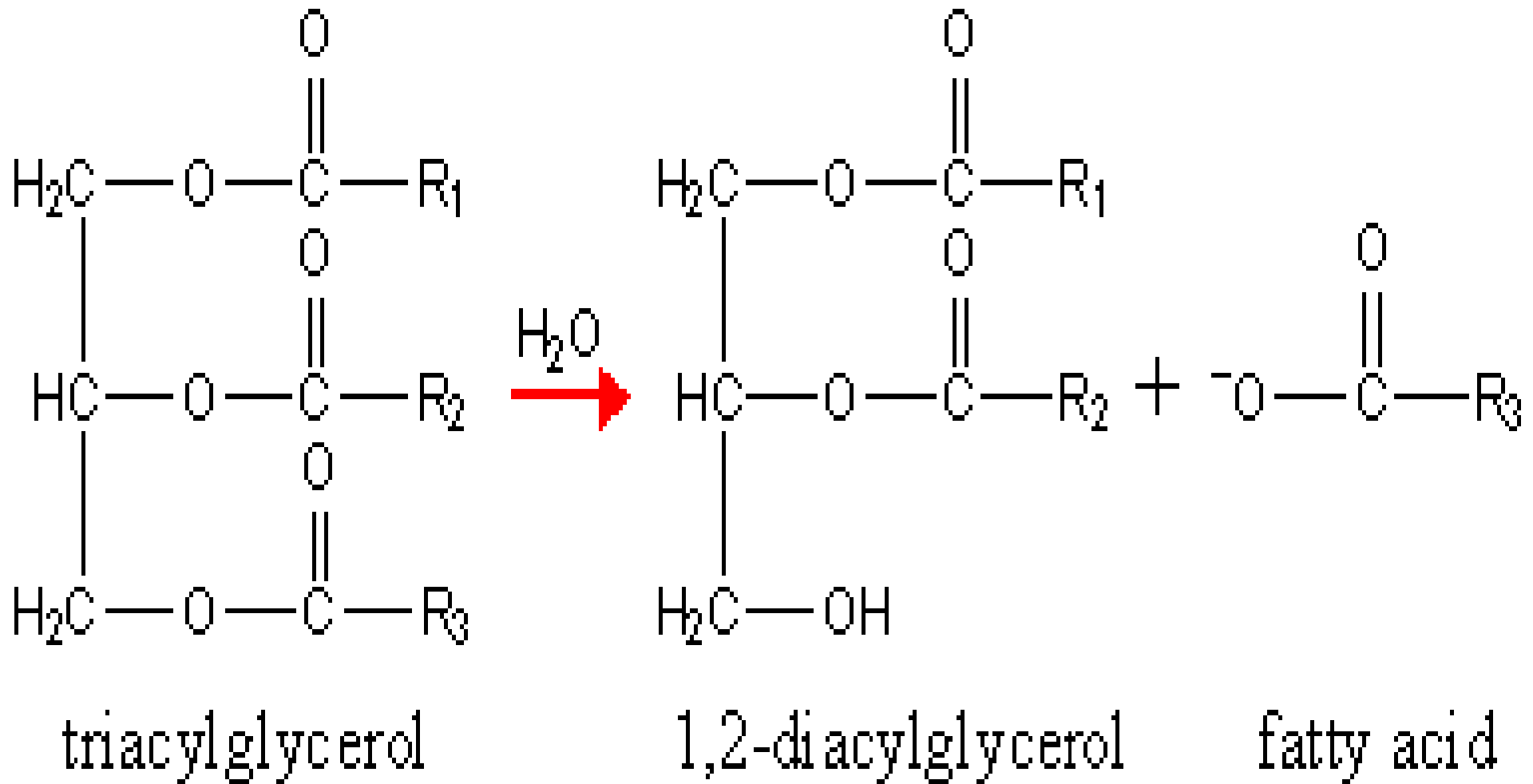

Absorption, Micelle

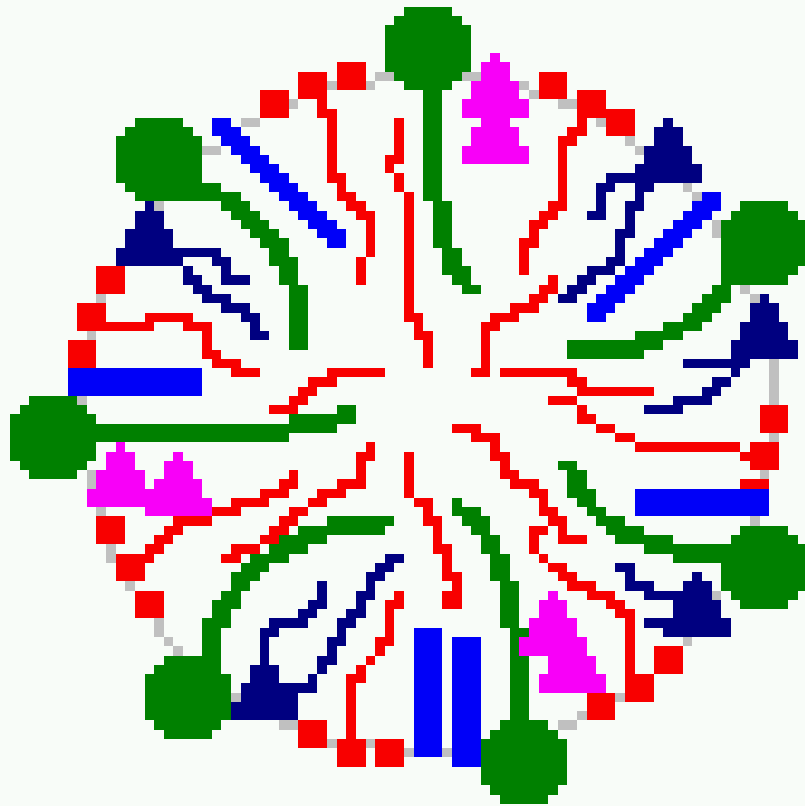

Bile salts
Monoglyceride
Fatty acids
Phospholipids
Cholesterol

FA, MAG delivered to cell membrane

Micelle

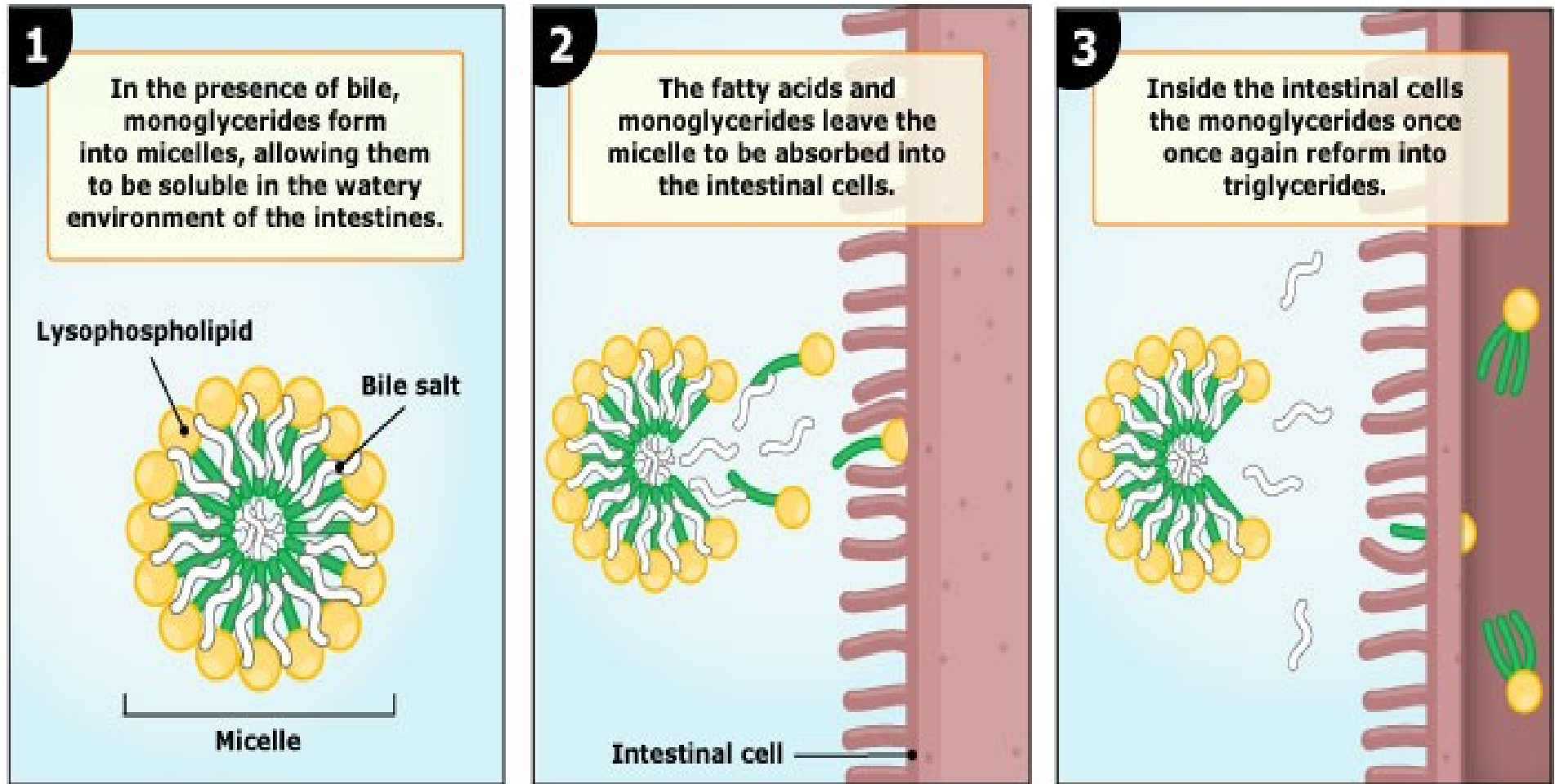

Bile Acid absorbed in Ileum

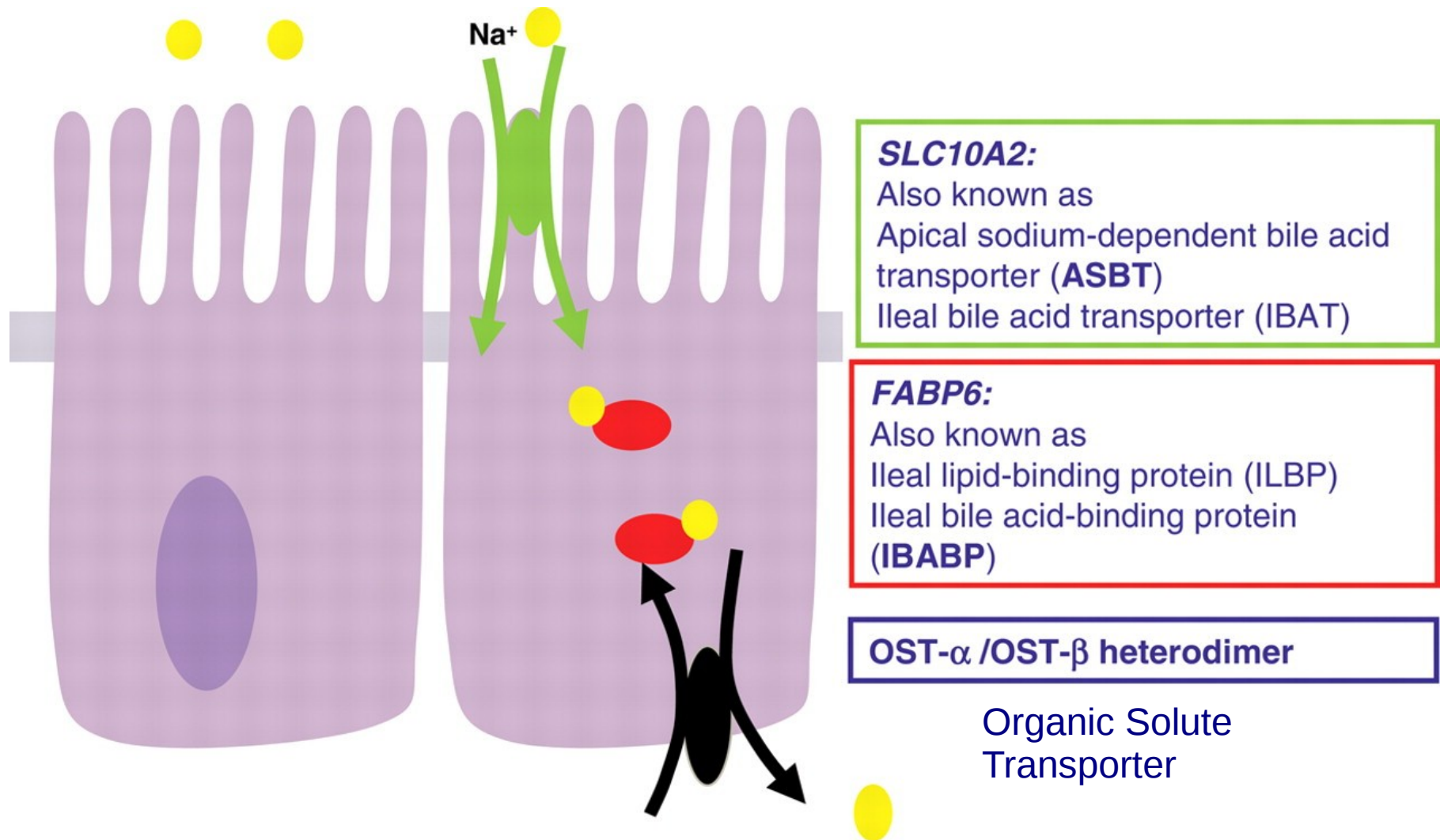

Pattni S , and Walters J R F Br Med Bull 2009;92:79-93

Intestine Form Chylomicron

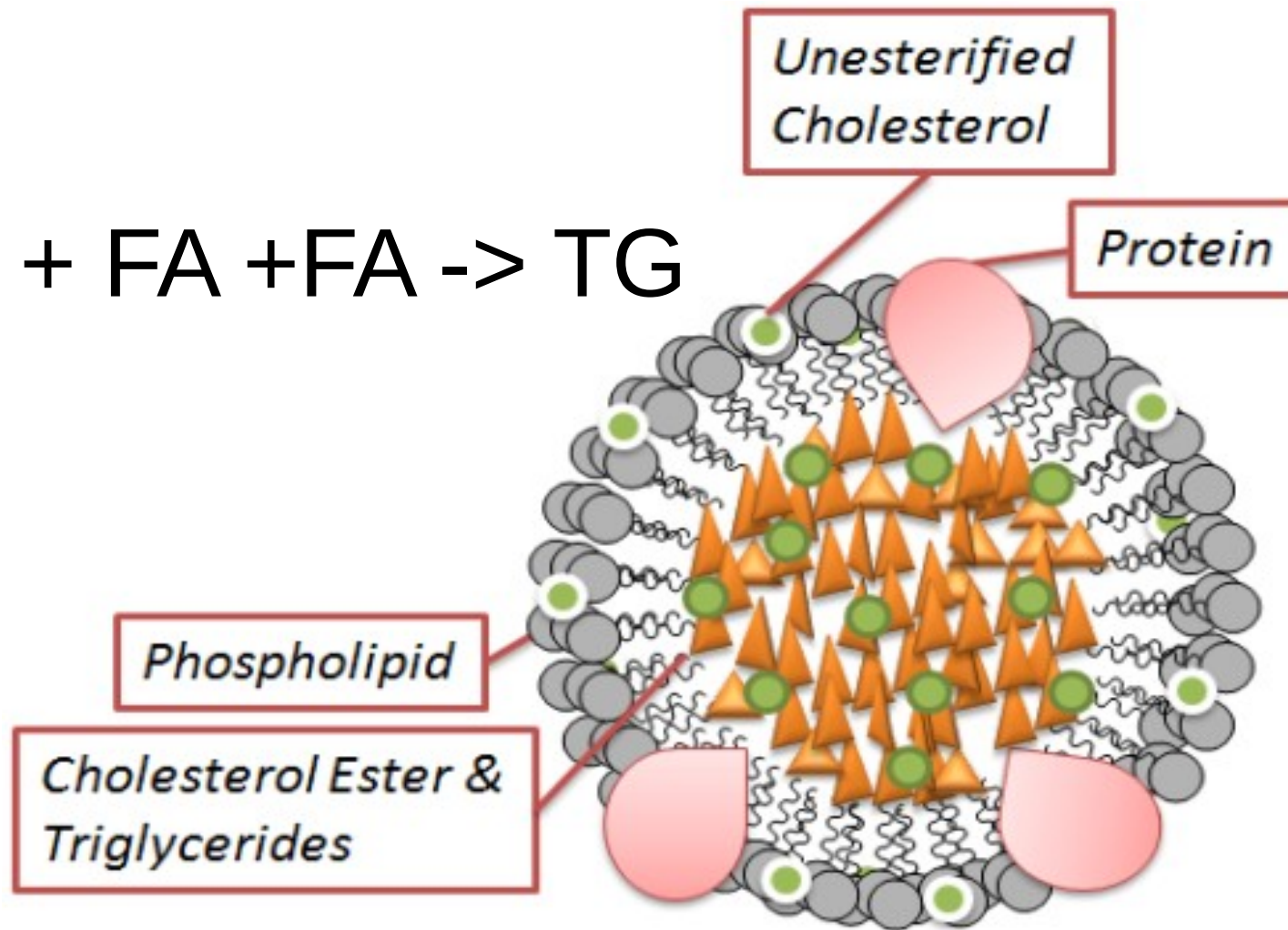
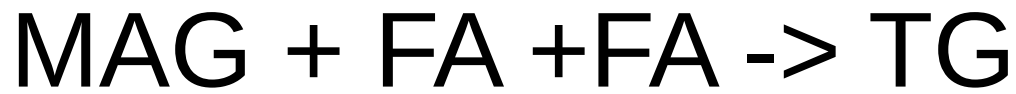

Figure 1. Schematic diagram of a Lipoprotein.

TG in blood

H-Bond

Water solubility

Unique Transport system

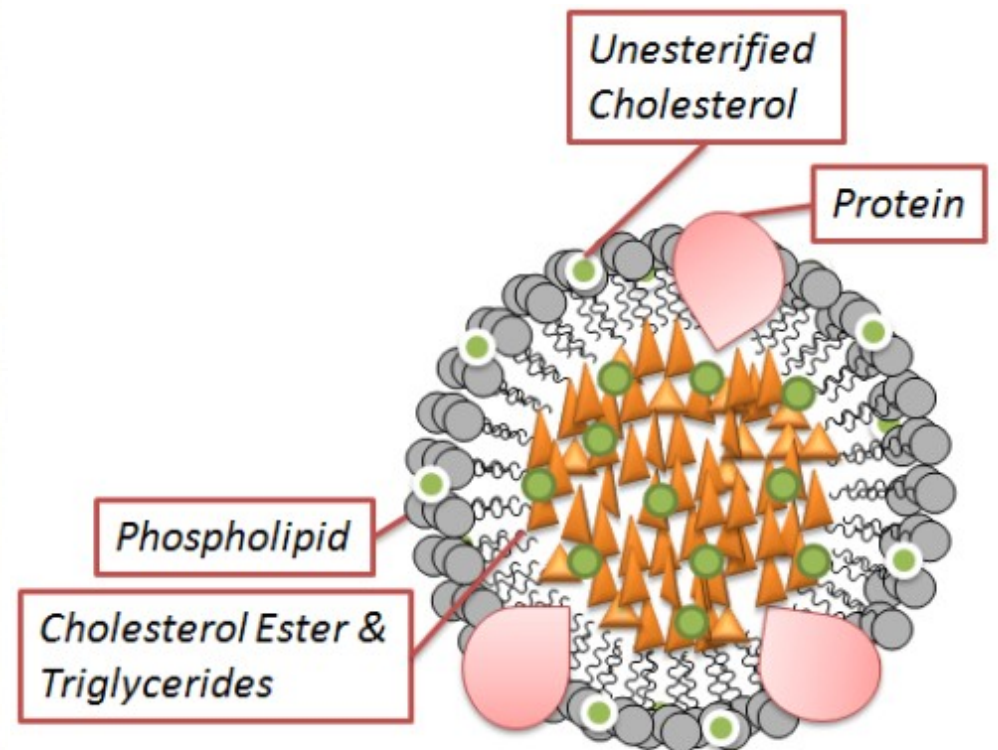
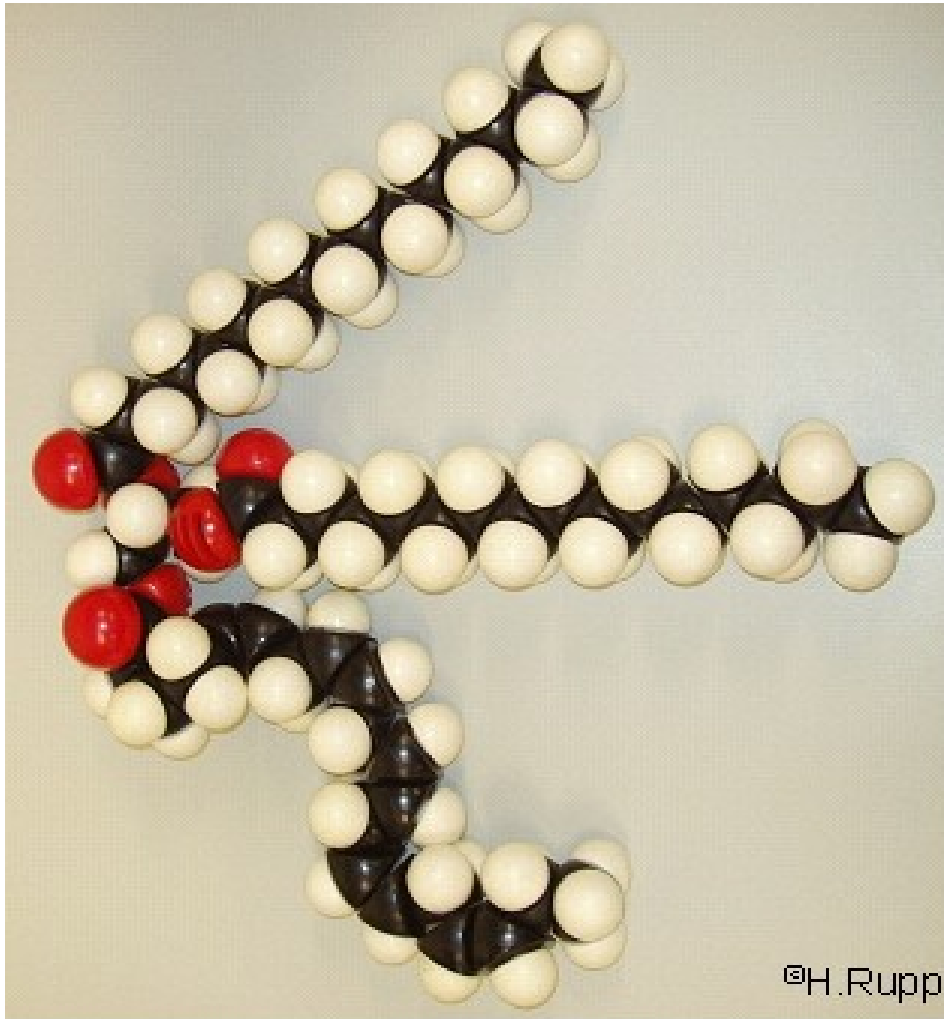
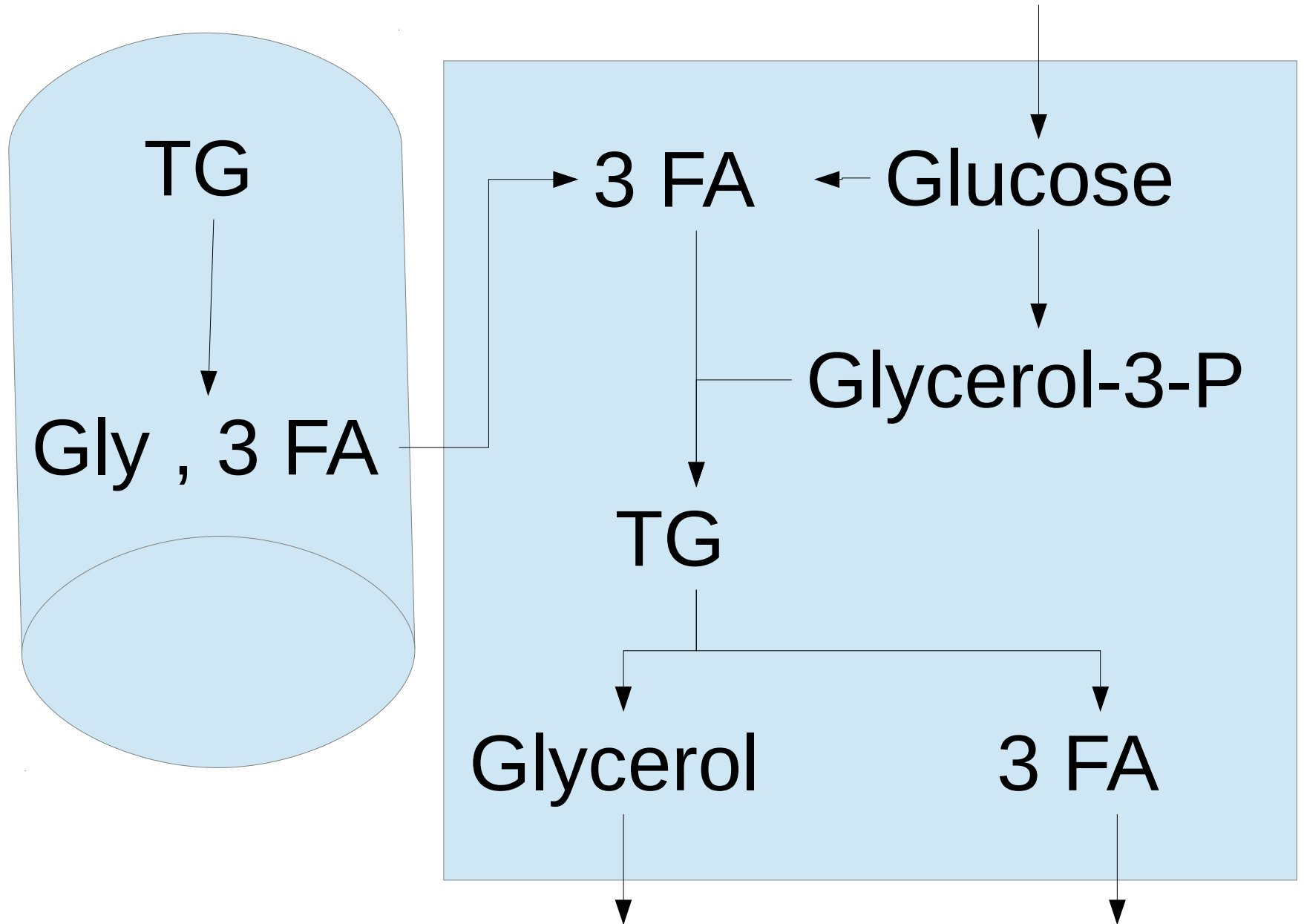

Figure 1. Schematic diagram of a Lipoprotein.

FA enters adipose tissue



FA enter in a liver cell

Aceto acetate,
beta-
HydroxyButyrate

← 3 FA

Glycerol

Glycerol-3-P

TG

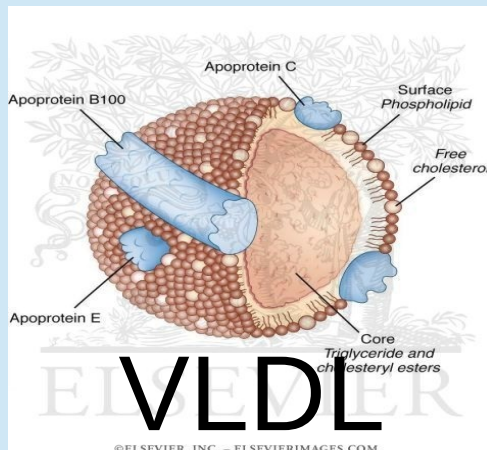

FA enter in a general cell

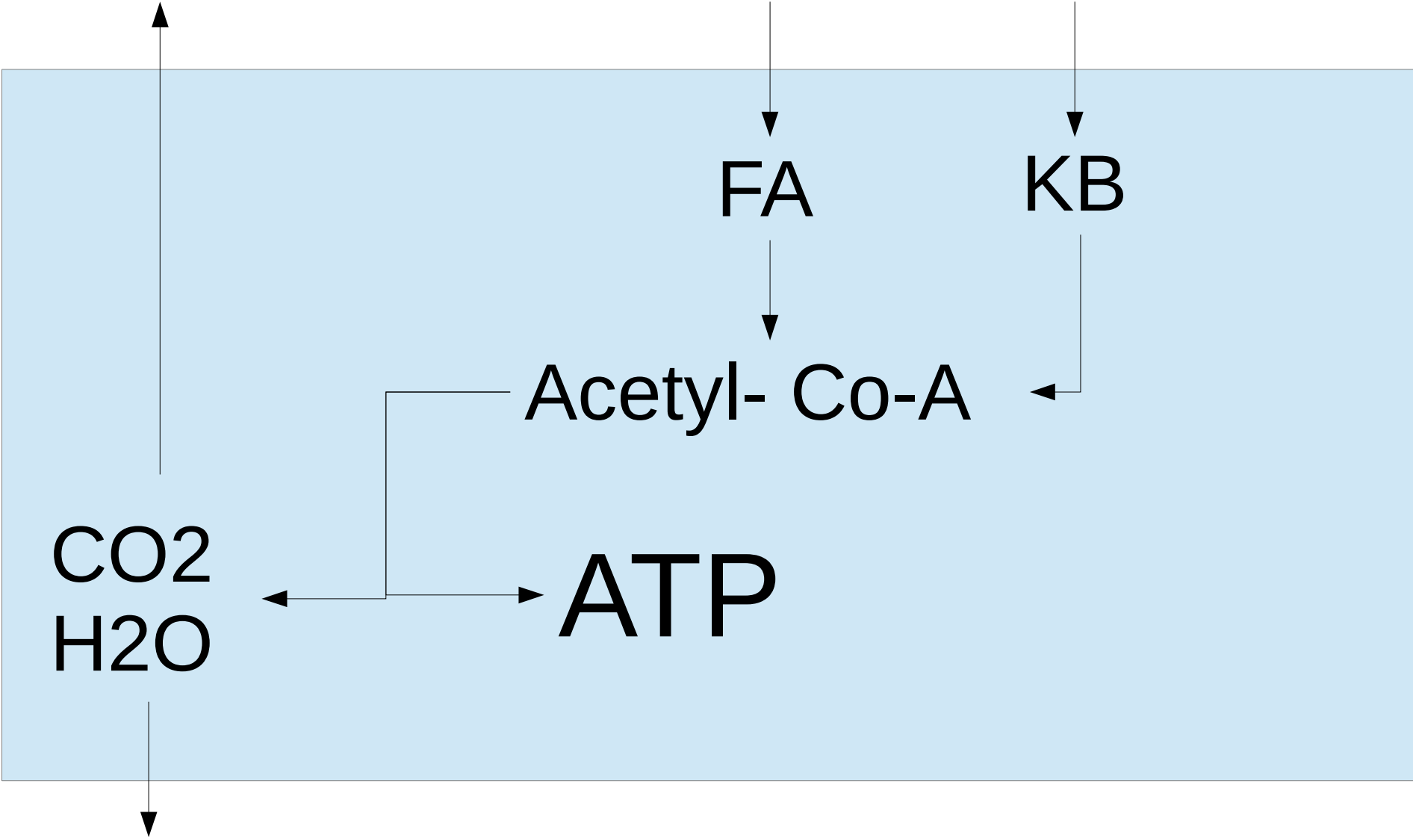

Food

Life of FA

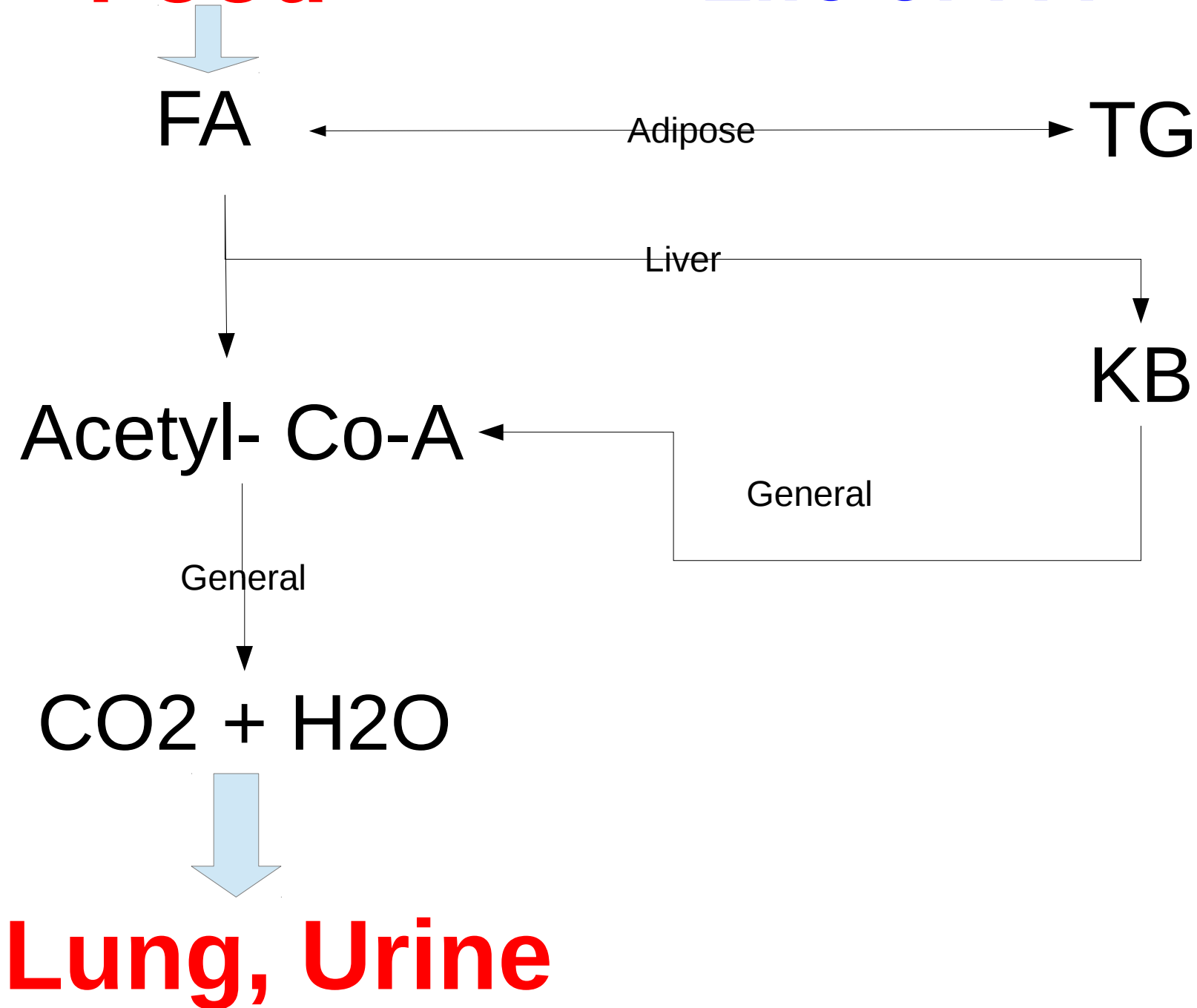

Fatty acid

Is not Triacylglycerol

Is not Fat

Is not the only Lipid

Is not Cholestrol

Is thin and lean

BioJokes

Why did the bear
dissolve in water?

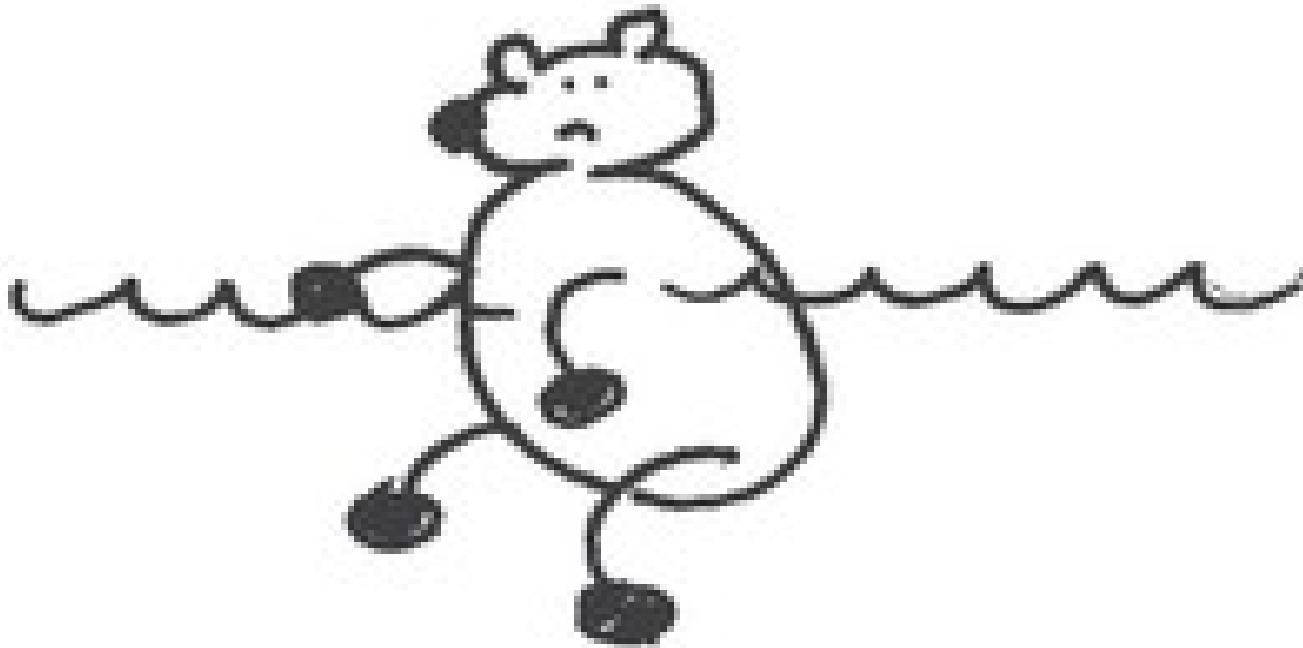

It was a polar bear!

Over reaction

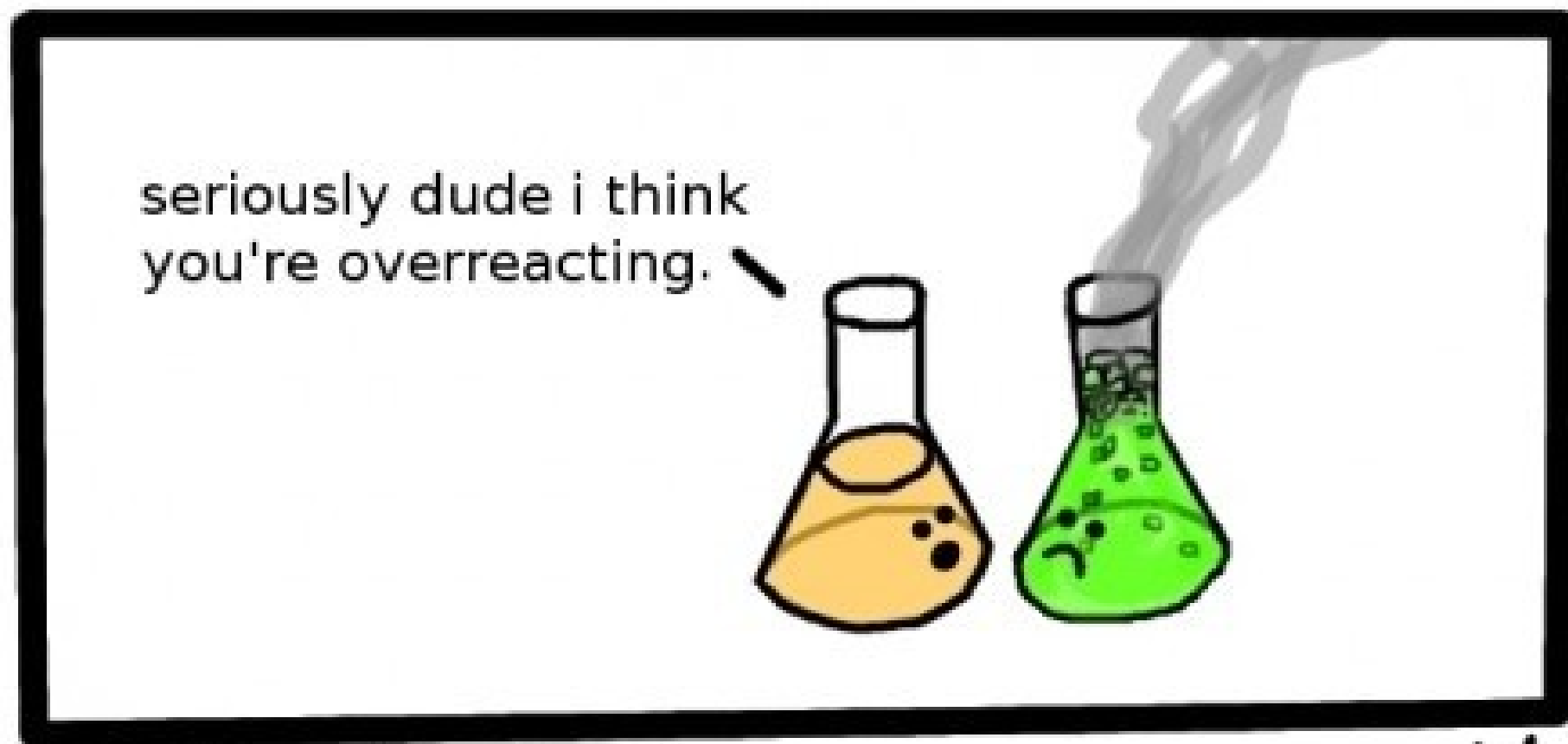

SticKycinemafloor.tumblr.com

you just lost The Game by 9GAG.COM

What does this look like to you?



If it looks like a plain hat, you're an adult

What does this look like to you?



If you think that
It is a Jerry hiding from Tom, You
are still a child

What does this look like to you?

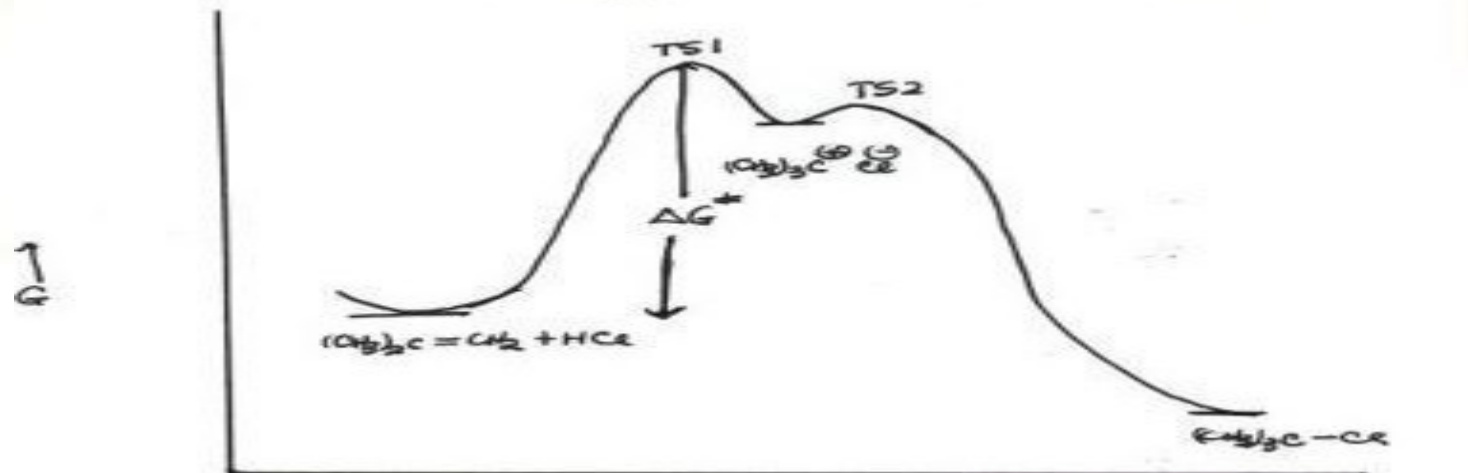

If U say It is a Free Energy Curve,
You are hopeless Biochemistry student